

• AC • Accessories • Body Shop • Chemicals • Collision • Hard Parts • Paint • Shop & More

CELEBRATING 100 YEARS OF SERVING PROFESSIONALS

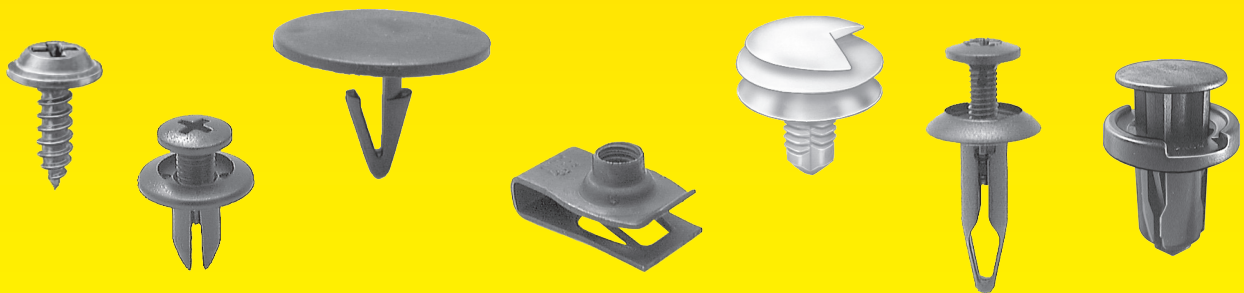

AUTO BODY FASTENERS CATALOG



CALL 1-800-438-4070 TO ORDER

FAX 24/7: 1-800-377-7016 / HOURS: MON-FRI 8AM-5:30PM / www.autosupplyhouse.com / sales@autosupplyhouse.com



Table of Contents

Part Number Index

1			
1001PK	14	10536PK	30
1003PK	44	10538PK	35
10056PK	48	10568PK	24
10058PK	48	10569PK	30
10059PK	48	10570PK	30
10060	44	10573PK	41
10064PK	24	10575PK	41
10075PK	32	10576PK	42
10096PK	12	10587PK	57
10112PK	49	10589PK	57
10113PK	50	10639PK	52
10128PK	48	10640PK	52
10129PK	48	10641PK	52
1013PK	15	10642PK	52
10141PK	38	10643PK	52
1017PK	19	10644PK	52
101PK	17	10645PK	52
10239PK	32	10646PK	52
1024PK	39	10647PK	52
10356PK	32	10648PK	52
10357PK	46	10651PK	49
10365PK	12	10680PK	47
10366PK	25	10687PK	42
10367PK	29	10703PK	39
10368PK	29	10744PK	40
10369PK	29	10748PK	42
10370PK	31	10749PK	42
10371PK	32	10750PK	40
10372PK	32	10751PK	40
10374PK	32	10752PK	40
10375PK	33	10763PK	10
10377PK	33	1077PK	12
10378PK	33	10782PK	37
10382PK	34	10815PK	21
10392PK	49	10823PK	45
10394PK	50	10826PK	49
10396PK	49	10827PK	47
10397PK	49	1091PK	51
10405PK	41	1095PK	23
1041PK	18	10960PK	56
10424PK	28	10966PK	57
10429PK	48	10985PK	58
1042PK	18	11024PK	35
10435PK	30	11027PK	12
1044PK	18	11040PK	19
10450PK	29	11041PK	39
10455PK	13	11042PK	58
10464PK	41	11083PK	57
10480PK	46	11085PK	58
10481PK	46	11135PK	14
10482PK	47	11136PK	19
10485PK	46	11137PK	29
10488PK	46	11191PK	19
10489PK	46	11284PK	23
10490PK	50	11288PK	53
10491PK	49	11289PK	53
10492PK	50	11290PK	53
10493PK	49	11291PK	53
10504PK	32	11292PK	53
		11293PK	53
		11294PK	53
		11295PK	52
		11296PK	52
		11297PK	52
		11298PK	52
		11299PK	52
		11300PK	53
		11301PK	54
		11302PK	53
		11303PK	54
		11304PK	53
		11305PK	55
		11306PK	54
		11307PK	54
		11308PK	54
		11309PK	54
		11310PK	54
		11311PK	54
		11327	14
		11387PK	28
		11389PK	23
		1172PK	45
		1183PK	9
		1184PK	9
		1185PK	9
		1186PK	9
		1192PK	20
		1195PK	55
		1228PK	13
		1228PK	23
		1239PK	59
		1263PK	31
		1267PK	42
		1268PK	43
		1276PK	17
		1282PK	17
		1288PK	43
		1296PK	22
		1302PK	51
		1303PK	10
		1350PK	20
		1363PK	16
		1364PK	16
		1365PK	16
		1366PK	16
		1367PK	16
		1368PK	16
		1379PK	51
		1390PK	55
		1446PK	35
		1466PK	28
		1558PK	40
		1560PK	22
		1572PK	22
		1574PK	22
		1575PK	41
		1576PK	22
		1577PK	22
		1583PK	24
		1584PK	44

Table of Contents

Part Number Index

1597PK	34	2029PK	39	5560PK	21
1601PK	21	2048PK	26	5596PK	21
1603PK	34	2060PK	35	5602PK	23
1605PK	23	2063PK	41	5605PK	23
1609PK	56	2063PK	40	5606PK	28
1614PK	22	2108PK	41	5609PK	24
1620PK	13	2111PK	36	5610PK	24
1621PK	17	2112PK	40	5614PK	24
1623PK	11	2114PK	43	5618PK	24
1624PK	11	2115PK	43	5625PK	25
1625PK	11	2123PK	13	5627PK	25
1634PK	28	2128PK	30	5628PK	25
1636PK	22	2133PK	31	5632PK	25
1639PK	19	2145PK	42	5635PK	26
1640PK	9	2153PK	36	5640PK	26
1641PK	10	2167PK	36	5643PK	27
1642PK	10	263PK	18	5648PK	27
1646PK	38	265PK	18	10812PK	21
1650PK	14	2940PK	22	5672PK	33
1654PK	16	2969PK	20	5675PK	29
1655PK	16	2970PK	11	5676PK	31
1656PK	16	2975PK	11	5677PK	33
1657PK	16	2980PK	22	5682PK	15
1684PK	17	3		5684PK	14
1687PK	17	3010PK	17	5686PK	15
1723PK	11	308PK	50	5688PK	15
1724PK	11	3201PK	16	5690PK	15
1742PK	41	3202PK	16	5692PK	14
1756PK	28	345PK	51	5697PK	15
1799PK	56	347PK	50	5698PK	14
1835PK	20	4		5705PK	15
1836PK	20	4002PK	56	5710PK	27
1842PK	22	4005PK	56	5750PK	20
1851PK	13	4007PK	56	5751PK	20
1860PK	31	4008PK	57	5752PK	20
1861PK	31	4009PK	56	5760PK	9
1864PK	45	4020PK	38	5761PK	9
1865PK	37	4063PK	16	5769PK	55
1889PK	57	4070PK	16	5770PK	55
1890PK	57	4072PK	16	5775PK	55
1900PK	57	4088PK	16	5791PK	11
1901PK	57	4090PK	16	5797PK	18
1904PK	57	4096PK	16	5800PK	18
1930PK	36	4098PK	16	5805PK	19
1939PK	13	4107PK	16	589PK	17
1949PK	31	477PK	13	5901PK	35
1950PK	38	5		5910PK	19
1951PK	57	5264PK	39	5915PK	19
1971PK	13	5412PK	20	5916XPK	19
1973PK	35	5429PK	25	5920PK	34
1975PK	31	5440PK	36	5925PK	12
1976PK	34	5466PK	21	592PK	39
1991PK	27	5480PK	20	5935PK	29
1996PK	28	5506PK	25	5940PK	31
2		5550PK	12	5950PK	12
2015PK	34	5552PK	13	5955PK	12
2016PK	27	5554PK	13	5984PK	11
2017PK	39	5558PK	21	5989PK	11
2025PK	38	5559PK	21	5995PK	27
2028PK	34			6	

Table of Contents

Part Number Index

6010PK	10	9249PK	14	9915PK	47
6016PK	58	9256PK	10	991PK	18
6185PK	10	9260PK	10	9934PK	13
6265PK	10	9262PK	28	9943PK	32
6293PK	9	9264PK	27	9945PK	37
6301PK	9	9277PK	56	9946PK	50
6302PK	9	9278PK	56	9948	44
639PK	37	9279PK	59	9967PK	46
6401PK	9	9282PK	33	9968PK	34
6402PK	9	9287PK	34	9969PK	45
6411PK	9	9292PK	30	9974PK	58
688PK	17	9294PK	33	9975PK	58
8		9325PK	59	9980PK	37
80321	64	9327PK	32	9990PK	47
8051	63	9339PK	39	9991PK	47
8109	59	9346PK	12	9992PK	47
812PK	38	9352PK	27	D	
8150	59	9368PK	39	D-123PK	35
8172PK	24	9369PK	29	D-124PK	35
8173	60	9370PK	33	J	
8174	60	9371PK	16	JL-120PK	26
8175	60	9372PK	40	JL-23PK	24
8177	60	9373PK	40	JL-24PK	23
8184	61	9374PK	26	JL-26PK	24
8185	61	9382PK	33	JL-32PK	23
856PK	18	9386PK	51	JL-33PK	26
8601	61	938PK	20		
8603	62	9444PK	41		
8620	62	9465PK	30		
8637	62	9489PK	10		
8862BPK	26	9497PK	11		
9		9498PK	11		
9050PK	22	9498PK	10		
9053PK	55	9539PK	42		
9054PK	55	9540PK	30		
9064PK	15	9548PK	45		
9067PK	34	9550PK	45		
9074PK	28	9554PK	28		
9081PK	42	9559PK	29		
9111PK	21	9560PK	27		
9114PK	30	9588PK	37		
9118PK	56	9591PK	21		
9128PK	55	9596PK	57		
9130PK	25	9617PK	28		
9132PK	26	9646PK	35		
9145PK	11	9711PK	51		
9146PK	11	972PK	44		
9147PK	15	9818	43		
9160PK	10	9825PK	43		
9161PK	9	9849PK	26		
9164PK	43	9851PK	56		
9178PK	24	9854PK	55		
9199PK	45	9871PK	12		
9202PK	35	9879PK	50		
9208PK	27	9888PK	12		
9226PK	18	9892PK	19		
9233PK	42	9902PK	56		
9242PK	38	9912PK	23		
9243PK	57	9913PK	23		
		9914PK	47		

Table of Contents

Alphabetized Listing

A

Acura Hood Insulation Retainers	37
AMC Door Panel Retainers	40
Assortment Body Bolt & Nut	62
Assortment Body Shop Fastener	63
Assortment Cotter Pin	61
Assortment Ergo Tufloks Retainer	62
Assortment G.M. Rocker Panel Moulding	62
Assortment Honda Retainer	60
Assortment Import Door Trim Panel	59
Assortment Moulding Clip	60
Assortment Nissan Retainer	60
Assortment Rod End Clip	61
Assortment Shield Retainer	61
Assortment Toyota Retainer	60
Assortment Weatherstrip Retainer	59
Assortments	59-63

B

Body Bolts Hex Head Flange Metric	15
Body Bolts L/W Hex Head Metric	14-15
Body Bolts L/W Hex Head Standard	14
Bumper Hardware	44

C

Cable Ties Nylon	59
Chrysler Door Panel Retainers	41
Chrysler Hood Insulation Retainers	37
Cotter Pins Hammercok Type	16

D

Door Fasteners	38-44
Door Handle Clips	38
Door Hinge Pin & Bushing Kits	43-44
Door Hinge Pin Bushings	42-43
Door Hinge Pins	43

E

Electrical Products	59
---------------------	----

F

Fasteners Standard & Metric	14-16
Flatwashers Metric Din # 125	16
Flatwashers SAE	16
Ford Door Panel Retainers	40-41
Ford Hood Insulation Retainers	36-37

G

G.M. Door Panel Retainers	38-39
G.M. Grille Fasteners	45
G.M. Hood Insulation Retainers	36
G.M. Moulding Clips	45-46

H

Headlight & Grille Fasteners	44-45
Headlight Retainers	45
Headlight Screw & Nuts	44
Hog Rings	17
Hole Plugs	51
Hole Plugs Depressed Center Black	51
Hole Plugs Flush Type Black	51
Honda Door Panel Retainers	41
Hood Insulation Retainers	36-38
Hyundai Hood Insulation Retainers	37

L

Lexus Moulding Clips	49
----------------------	----

License Plate Hardware

13-14

M

Mazda Door Panel Retainers	41-42
Moulding Clips	45-51
Mounting Hardware	16-17

N

Nissan Door Panel Retainers	42
Nissan Hood Insulation Retainers	38
Nuts	17-23
Nuts "U" Type	19-20
Nuts "U" Type Nylon	21
Nuts "U" Type Speed	19
Nuts Class 10.9 Spin Lock Type	16
Nuts Extruded "U" Type Metric	21
Nuts Extruded "U" Type Standard	20-21
Nuts Flat Type	17
Nuts Hex Flange	18-19
Nuts Hex Loose Washer	19
Nuts Jack	16-17
Nuts Machine Screw	17
Nuts Nylon	21-22
Nuts Push On Non-Threaded Stud	17
Nuts Push On Threaded Stud	17-18
Nuts Rubber Well	23
Nuts Thread Cutting	18

P

Pop Rivets Aluminum	57
Pop Rivets Automotive	56
Pop Rivets Nylon	55
Pop Rivets Steel	57-58

R

Retainers	23-35
Retainers Christmas Tree	23-24
Retainers Panel	28
Retainers Phillips Screw Type	34-35
Retainers Push Type	28-29
Retainers Weatherstrip	27
Reveal Moulding	45
Rivets	55-58

S

Saturn Moulding Clips	49
Screws	9-14
Screws Hex Head Loose Washer Tek Black	13
Screws Hex Head Tek Zinc	12-13
Screws Hex Loose Washer Head Black	12
Screws Phillips Flat Top Black	11
Screws Phillips Flat Top Washer Head Tek Black	12
Screws Phillips Oval Head Black	9
Screws Phillips Oval Head Chrome	9
Screws Phillips Oval Loose Washer Head Black Trim	9-10
Screws Phillips Oval Loose Washer Head Chrome Trim	9
Screws Phillips Oval Undersized Head Black	9
Screws Phillips Oval Undersized Head Chrome	9
Screws Phillips Oval Washer Head Black	10
Screws Phillips Oval Washer Head Tek Black	10
Screws Phillips Oval Washer Head Tek Chrome	10
Screws Phillips Pan Head Black	11
Screws Phillips Pan Head Zinc	13
Screws Phillips Pan Loose Washer Head Black	12
Screws Phillips Trim	9

Table of Contents

Alphabetized Listing

S

Screws Phillips Truss Loose Washer Head Black	12
Screws Phillips Truss Washer Head Black	10
Service Equipment	64
Shims	58
Shims Body Steel	58
Storage Cabinet	64

T

Toyota Bumper Hardware	44
Toyota Door Panel Retainers	42
Toyota Hood Insulation Retainers	38
Toyota Moulding Clips	49-50

U

Universal Moulding Clips	50-51
--------------------------	-------

V

Vacuum Caps	52
Vacuum Caps & Connectors	52-53
Vacuum Connectors	52-53

W

Windshield Fasteners	45
Wire Loom Routing Clips	59

Screws

Screws Phillips Trim

9161PK 4.2-1.41 x 12mm Phillips Pozi-Driv Washer Head
10mm O.D. Washer
Chrome Finish Trim Screws
G.M. # 11501794 **100 Pcs.**



Screws Phillips Oval Undersized Head Chrome

6401PK 8 x 3/4" #6 Head
Phillips Oval Head
Chrome Finish Sheet Metal Screws **100 Pcs.**



6402PK 8 x 1" #6 Head
Phillips Oval Head
Chrome Finish Sheet Metal Screws **100 Pcs.**



6411PK 10 x 1" #8 Head
Phillips Oval Head
Chrome Finish Sheet Metal Screws **100 Pcs.**



Screws Phillips Oval Head Chrome

6293PK 6 x 1/2" #6 Head
Phillips Oval Head
Chrome Finish Sheet Metal Screws **100 Pcs.**



6301PK 8 x 3/4" #8 Head
Phillips Oval Head
Chrome Finish Sheet Metal Screws **100 Pcs.**



6302PK 8 x 1" #8 Head
Phillips Oval Head
Chrome Finish Sheet Metal Screws **100 Pcs.**



Screws Phillips Oval Undersized Head Black

1184PK 8 x 3/4" #6 Head
Phillips Oval Head
Black Finish Sheet Metal Screws **100 pcs.**



1186PK 8 x 1" #6 Head
Phillips Oval Head
Black Finish Sheet Metal Screws **100 pcs.**



Screws Phillips Oval Head Black

1183PK 8 x 3/4" # 8 Head
Phillips Oval Head
Black Finish Sheet Metal Screws **100 Pcs.**



1185PK 8 x 1" #8 Head
Phillips Oval Head
Black Finish Sheet Metal Screws **100 Pcs.**



Screws Phillips Oval Loose Washer Head Chrome Trim

5760PK 8 x 3/4" # 6 Head Phillips Oval
1/2" O.D. Loose Washer
Chrome Finish Sems® Trim Screws **100 Pcs.**



5761PK 8 x 1" # 6 Head Phillips Oval
1/2" O.D. Loose Washer
Chrome Finish Sems® Trim Screws
G.M. **100 Pcs.**



Screws Phillips Oval Loose Washer Head Black Trim

1640PK 8 x 3/4" # 6 Head Phillips Oval
1/2" O.D. Loose Washer
Black Finish Sems® Trim Screws
G.M. **100 Pcs.**



Screws

Screws Phillips Oval Loose Washer Head Black Trim

1641PK 8 x 1" # 6 Head Phillips Oval
1/2" O.D. Loose Washer
Black Finish Sems® Trim Screws
G.M. **100 Pcs.** 

9489PK 10 x 3/4" # 8 Head Phillips Oval
15/32" O.D. Loose Washer
Black Finish Sems® Trim Screws **50 Pcs.** 

9498PK 10 x 1" # 8 Head Phillips Flat Top
15/32" O.D. Washer Head
Black Finish Sems® Trim Screws
G.M. **50 Pcs.** 

1303PK 8 x 3/4" # 6 Head Phillips Oval
1/2" O.D. Loose Washer
Black Finish Tek® Sems® Trim Screws
G.M. **100 Pcs.** 

1642PK 8 x 1" # 6 Head Phillips Oval
1/2" O.D. Loose Washer
Black Finish Tek® Sems® Trim Screws
G.M. **100 Pcs.** 

Screws Phillips Oval Washer Head Black

9160PK 8 x 3/4" Phillips Oval Washer Head
13/32" O.D. Washer Size
Black Finish Trim Screws
G.M. # 11501884 **100 Pcs.** 

Screws Phillips Oval Washer Head Tek Chrome

6185PK 8 x 1/2" Phillips Oval Washer Head
7/16" O.D. Washer Size
Chrome Finish Wheel Opening Mldg. Tek® Screws
G.M. **50 Pcs.** 

Screws Phillips Oval Washer Head Tek Black

6010PK 8 x 1/2" Phillips Oval Washer Head
7/16" O.D. Washer Size
Black Finish Tek® Wheel Opening Mldg. Screws
G.M. # 20423550 Ford # 381801-S2 **50 Pcs.** 

6265PK 8 x 3/4" Phillips Oval Washer Head
7/16" O.D. Washer Size
Black Finish Teks® Mounting Screws
G.M. **50 Pcs.** 

Screws Phillips Truss Washer Head Black











9256PK 4.8-1.6 x 15mm Phillips Truss Head
14mm O.D. Washer Size
Black Finish Sheet Metal Screws
Nissan **50 Pcs.** 

9260PK 6.3 - 1.81 x 16mm Phillips Truss Head
15mm O.D. Washer Size
Black Finish Sheet Metal Screws
G.M. **50 Pcs.** 

















10763PK 4.8-1.61 x 16mm Phillips Truss Head
14mm O.D. Washer Size
Black Zinc Finish Sheet Metal Screws
Hyundai # 12493-05167B **100 Pcs.** 

Screws

Screws Phillips Pan Head Black

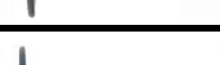
1623PK	8 x 1/2" Phillips Pan Head Black Finish Sheet Metal Screws	100 Pcs.		
1624PK	8 x 3/4" Phillips Pan Head Black Finish Sheet Metal Screws	100 Pcs.		
1625PK	8 x 1" Phillips Pan Head Black Finish Sheet Metal Screws	100 Pcs.		
1723PK	10 x 3/4" Phillips Pan Head Black Finish Sheet Metal Screws	100 Pcs.		
1724PK	10 x 1" Phillips Pan Head Black Finish Sheet Metal Screws	50 Pcs.		

Screws Phillips Flat Top Black

5791PK	8 x 1/2" Phillips Flat Top 13/32" O.D. Washer Head Black Finish Trim Screws G.M. # 11505104 Ford # 56902-S2	100 pcs.		
5984PK	8 x 3/4" Phillips Flat Top 13/32" O.D. Washer Head Black Finish Trim Screws G.M. # 11504766 Ford # 56904-S2 Chrysler # 9428738, 6032723	100 Pcs.		
5989PK	8 x 1" Phillips Flat Top 13/32" O.D. Washer Head Black Finish Trim Screws G.M.	100 Pcs.		
9497PK	10 x 3/4" Phillips Flat Top 15/32" O.D. Washer Head Black Finish Trim Screws G.M.	50 Pcs.		
9498PK	10 x 1" # 8 Head Phillips Flat Top 15/32" O.D. Washer Head Black Finish Sems® Trim Screws G.M.	50 Pcs.		
2970PK	8 x 3/4" Phillips Flat Top 1/2" O.D. Washer Head Black Finish Trim Screws Ford # 56912-S2, 56912-S61	100 Pcs.		
2975PK	8 x 1" Phillips Flat Top 1/2" O.D. Washer Head Black Finish Trim Screws Ford # 56914-S2	100 Pcs.		
9145PK	10 x 3/4" Phillips Flat Top 1/2" O.D. Washer Head Black Finish Trim Screws G.M.	50 Pcs.		
9146PK	10 x 1" Phillips Flat Top 1/2" O.D. Washer Head Black Finish Trim Screws G.M.	50 Pcs.		

Screws

Screws Phillips Flat Top Washer Head Tek Black

11027PK 8 x 1/2" Phillips Flat Top
13/32" O.D. Washer Head
Black Finish Tek® Trim Screws
Chrysler # 153297 **100 Pcs.**



Screws Phillips Pan Loose Washer Head Black

9871PK 8 x 3/4" Phillips Pan Head
1/2" O.D. Loose Washer
Black Finish Trim Screws
Ford **50 Pcs.**



10365PK 4.2-1.41 x 20mm Phillips Pan Head
16mm O.D. Loose Washer
Black Finish Trim Screws
Ford # N801603-S61 **50 Pcs.**



Screws Phillips Truss Loose Washer Head Black

10096PK 4.8-1.61 x 19mm Phillips Pan Head
16mm O.D. Loose Washer
Black Finish Trim Screws
Honda # 90114-SE0-000 **25 Pcs.**



Screws Hex Loose Washer Head Black

5925PK 4.2 - 1.41 x 20mm 7mm Indented Hex Head
12mm O.D. Loose Washer
Black Finish Sheet Metal Screws
G.M. # 11503396, 11503483 **50 Pcs.**



5550PK 4.2-1.41 x 20mm 7mm Indented Hex Head
17mm O.D. Loose Washer
Black Finish Trim Screws
G.M. # 11503892, 11500434, 11502449, 11503403 **50 Pcs.**



9888PK 4.2-1.41 x 20mm 7mm Indented Hex Head
12mm O.D. Loose Washer
Black Finish Trim Screws
G.M. # 11504056, 11513801 **50 Pcs.**



5950PK 6.3-1.81 x 20mm 10mm Indented Hex Head
17mm O.D. Loose Washer
Black Finish Sheet Metal Screws
G.M. # 11505022 **50 Pcs.**



5955PK 6.3-1.81 x 25mm 10mm Indented Hex Head
17mm O.D. Loose Washer
Black Finish Sheet Metal Screws
G.M. # 11500996, 11505023 **50 Pcs.**

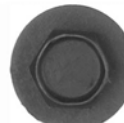

Screws Hex Head Tek Zinc

1077PK 8 x 1/2" 1/4" Indented Hex Head
11/32" O.D. Washer #2 Tek Point
Bright Zinc Finish Tek® Screws **100 Pcs.**



9346PK 10 x 3/4" 5/16" Indented Hex Head
13/32" O.D. Washer #2 Tek Point
Bright Zinc Finish Tek® Screws **100 Pcs.**



Screws

Screws Hex Head Tek Zinc

1971PK 14 x 1" 3/8" Indented Hex Head
1/2" O.D. Washer #3 Tek Point
Bright Zinc Finish Tek® Screws **25 Pcs.**



Screws Hex Head Loose Washer Tek Black

5554PK 4.2 - 1.41 x 20mm 7mm Indented Hex Head
12mm O.D. Loose Washer
Black Finish Tek® Screws
G.M. **50 Pcs.**



5552PK 4.2 - 1.41 x 20mm 7mm Indented Hex Head
17mm O.D. Loose Washer
Black Finish Tek® Screws
G.M. **50 Pcs.**



Screws Phillips Pan Head Zinc

1851PK 6 - 1.00 x 16mm
Phillips Pan Head
Bright Zinc Finish Machine Screws
Din # 7985 **50 Pcs.**



License Plate Hardware

1228PK #14 (6.3mm) Screw Size 5/8" Head 5/16" Stem
13/32" Hole Size
White Plastic License Plate Nuts
G.M. # 4755299, 3907444, 379046-S **50 Pcs.**



477PK 1/4" (#14) x 3/4" Slotted Truss Head
9/16" Head Diameter
Bright Zinc Finish License Plate Screws
Ford **100 Pcs.**



10455PK 6.3-1.81 X 16mm
Duo-Drive Truss Head
Silver Dacromet Finish License Plate Screws
G.M. # 9423101 **50 Pcs.**



1620PK 14 x 3/4" 3/8" Indented Hex Head Slotted
1/2" O.D. Washer Head
Bright Zinc Finish Sheet Metal Screws
G.M. **50 Pcs.**



2123PK 6-1.81 x 20mm 10mm Indented Hex Head Phillips
12mm O.D. Washer Head
Yellow Zinc Finish License Plate Screws
Honda # 91500-SM4-999AH Toyota # 93904-46320 **50 Pcs.**



9934PK 1/4" (#14) x 3/4" 3/8" Indented Hex Head Slotted
1/2" O.D. Washer Head
Black Finish License Plate Screws
G.M. **50 Pcs.**



1939PK 1/4" (#14) x 5/8" 5/16" Indented Hex Head Slotted
5/8" O.D. Washer Head
Black Finish License Plate Screws
Ford # N800369-S2 **50 Pcs.**



Screws

License Plate Hardware

1650PK 1/4" (#14) x 1/2"
1 1/8" Overall Length
Dealer License Plate Thumb Screws
G.M. **25 Pcs.**



11327 1/4-20 x 3/4" Slotted Truss Head
9/16" Head Diameter
Bright Zinc Finish License Plate Screw & Nut Kit
G.M. **100 Pcs.**



Fasteners Standard & Metric

Body Bolts L/W Hex Head Standard

9249PK 5/16-18 x 1" 1/2" Indented Hex Head
7/8" O.D. Loose Washer
Black Finish Type CA Body Bolts
G.M. **25 Pcs.**

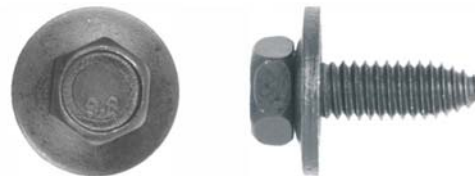

1001PK 3/8-16 x 1 1/2" 9/16" Indented Hex Head
1 1/8" O.D. Loose Washer
Black Finish Type CA Body Bolts
G.M. # 407217, 1564180 **25 Pcs.**

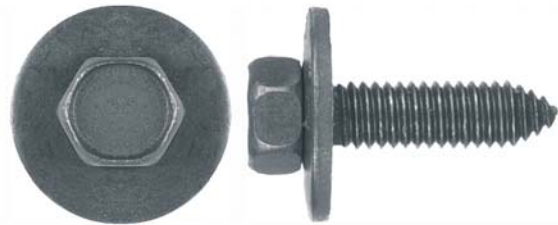

Body Bolts L/W Hex Head Metric

5684PK 6-1.00 x 20mm 10mm Indented Hex Head
17mm O.D. Loose Washer
Black Finish Metric Type CA Body Bolts
G.M. # 11502941, 11506174, 11503823, 11503941 **50 Pcs.**



11135PK 6-1.00 x 30mm 10mm Indented Hex Head
24mm O.D. Loose Washer
Black Finish Metric Type CA Body Bolts
G. M. # 11503825 **50 Pcs.**



5692PK 6 - 1.00 x 35 mm 10mm Indented Hex Head
17mm O.D. Loose Washer
Black Finish Metric Type CA Body Bolts
G.M. # 11505044 **50 Pcs.**





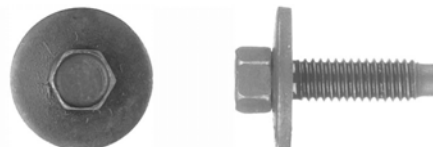







5698PK 6-1.00 x 22mm 8mm Indented Hex Head
9mm O.D. Loose Washer
Black Finish Metric Dog Point Body Bolts
Ford # N606676-S2, N606676-S, N606676-S100
Chrysler # 6100566 **25 Pcs.**



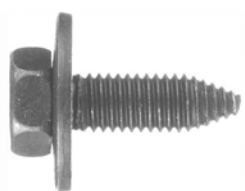

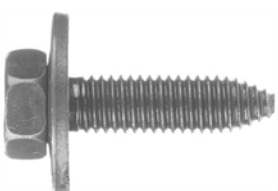

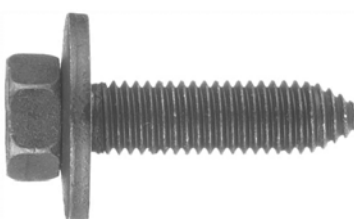
Fasteners Standard & Metric

Body Bolts L/W Hex Head Metric

5705PK	6 - 1.00 x 28mm 8mm Indented Hex Head 19mm O.D. Loose Washer Black Diachromate Finish Metric Dog Point Body Bolts Ford # N606677-S	25 Pcs.		
5686PK	6-1.00 x 25mm 10mm Indented Hex Head 17mm O.D. Loose Washer Black Finish Metric Type CA Body Bolts G.M. # 11503834, 20351035	50 Pcs.		
5690PK	6-1.00 x 25mm 10mm Indented Hex Head 24mm O.D. Loose Washer Black Finish Metric Type CA Body Bolts G.M. # 11503982	50 Pcs.		
9147PK	8-1.25 x 25mm 13mm Indented Hex Head 24mm O.D. Loose Washer Black Finish Metric Type CA Body Bolts G.M. # 11503619, 11501102	25 Pcs.		
5688PK	8-1.25 x 30mm 13mm Indented Hex Head 24mm O.D. Loose Washer Black Finish Metric Type CA Body Bolts G.M. # 11501188, 11500754	25 Pcs.		
9064PK	10-1.50 x 40mm 15mm Indented Hex Head 28mm O.D. Loose Washer Black Finish Metric Type CA Body Bolts G.M. # 11501193	25 Pcs.		

Body Bolts Hex Head Flange Metric

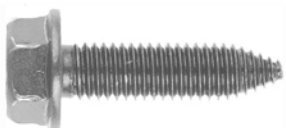
5682PK	6 - 1.00 x 20mm 10mm Indented Hex Head 13mm O.D. Flange Size Black Organic Finish Metric Type CA Flange Bolts G.M. # 11503800 Chrysler # 34201287	50 Pcs.		
1013PK	8-1.25 x 25mm 13mm Indented Hex Head 16mm O.D. Flange Size Black Finish Metric Type CA Body Bolts G.M. # 11500970	25 Pcs.		
5697PK	8 - 1.25 x 30mm 17mm O.D. Flange Size 13mm Indented Hex Head Black Organic Finish Metric Type CA Body Bolts G.M. # 11500971, 11504492, 11515619	25 Pcs.		

Fasteners Standard & Metric

Flatwashers SAE



1363PK	3/16" Bolt Size (SAE) 7/32" I.D. 1/2" O.D. Bright Zinc Finish Flatwashers	100 Pcs.
1364PK	1/4" Bolt Size (SAE) 9/32" I.D. 5/8" O.D. Bright Zinc Finish Flatwashers	100 Pcs.
1365PK	5/16" Bolt Size (SAE) 11/32" I.D. 11/16" O.D. Bright Zinc Finish Flatwashers	100 Pcs.
1366PK	3/8" Bolt Size (SAE) 13/32" I.D. 13/16" O.D. Bright Zinc Finish Flatwashers	100 Pcs.
1367PK	7/16" Bolt Size (SAE) 15/32" I.D. 15/16" O.D. Bright Zinc Finish Flatwashers	100 Pcs.
1368PK	1/2" Bolt Size (SAE) 17/32" I.D. 1 1/16" O.D. Bright Zinc Finish Flatwashers	100 Pcs.

Flatwashers Metric Din # 125



1654PK	6mm Bolt Size 6.4mm I.D. 12mm O.D. Bright Zinc Finish Metric Flatwashers	100 Pcs.
1655PK	8mm Bolt Size 8.4mm I.D. 14mm O.D. Bright Zinc Finish Metric Flatwashers	100 Pcs.
1656PK	10mm Bolt Size 10.5mm I.D. 21mm O.D. Bright Zinc Finish Metric Flatwashers	100 Pcs.
1657PK	12mm Bolt Size 13mm I.D. 24mm O.D. Bright Zinc Finish Metric Flatwashers	25 Pcs.

Cotter Pins Hammerlock Type



4063PK	1/16 x 1" Hammerlock Type Zinc Finish Cotter Pins	200 Pcs.
4070PK	3/32 x 1" Hammerlock Type Zinc Finish Cotter Pins	200 Pcs.
4072PK	3/32 x 1 1/2" Hammerlock Type Zinc Finish Cotter Pins	200 Pcs.
4088PK	1/8 x 1 1/2" Hammerlock Type Zinc Finish Cotter Pins	200 Pcs.
4090PK	1/8 x 2" Hammerlock Type Zinc Finish Cotter Pins	200 Pcs.
4096PK	5/32 x 1 1/2" Hammerlock Type Zinc Finish Cotter Pins	100 Pcs.
4098PK	5/32 x 2" Hammerlock Type Zinc Finish Cotter Pins	100 Pcs.
4107PK	3/16 x 2" Hammerlock Type Zinc Finish Cotter Pins	100 Pcs.

Nuts Class 10.9 Spin Lock Type

3201PK	8-1.25mm 12mm Hex Size 17mm Serrated Flange Class 10 Bright Zinc Finish Metric Spin Lock Nuts JIS B1190	50 Pcs.
---------------	--	----------------



3202PK	10-1.25mm 14mm Hex Size 20.5mm Serrated Flange Class 10 Bright Zinc Finish Metric Spin Lock Nuts JIS B1190	25 Pcs.
---------------	---	----------------



Mounting Hardware

Nuts Jack

9371PK	1/4-20" Thread Size 3/16" Grip Range Raintite Sealer Type Steel Jack Nuts G.M. # 367292 Chrysler # 6031438	25 Pcs.
---------------	---	----------------



Mounting Hardware

Nuts Jack

1282PK 1/4-20" Thread Size
3/16" Grip Range
Non Sealing Type Steel Jack Nuts

25 Pcs.



Hog Rings

589PK # 5 Size
For Attaching Seat Cushions
And Cushion Springs Metal Hog Rings

500 Pcs.



Nuts

Nuts Machine Screw

101PK 10 - 24 Screw Size
3/8" Hex Size
Bright Zinc Finish Machine Screw Nuts

100 Pcs.



Nuts Flat Type

688PK 1/8" Stud Size 5/16" x 9/16"
Flat Type
Black Finish Flat Type Speed Nuts

100 Pcs.



Nuts Push On Non-Threaded Stud

1684PK 1/8" Stud Size
3/8" Flange O.D.
Zinc Finish Push On Type Retainers

100 Pcs.



1687PK 1/4" Stud Size
17/32" Flange O.D.
Zinc Finish Push On Type Retainers

100 Pcs.



Nuts Push On Threaded Stud

1621PK 6 - 1.00mm Bolt Size
17mm Flange O.D.
Zinc Plated Push On Type Retainers
Ford # N801192S36 Chrysler # 6501178, 6501792

100 Pcs.

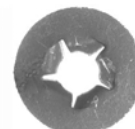

3010PK 8-1.25mm Bolt Size
24mm Flange O.D.
Dacromet Finish Bumper Strip Retainers
G.M. # 10009923

50 Pcs.

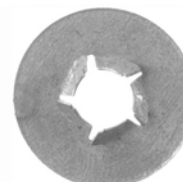

1276PK 10 - 1.50mm Bolt Size
24mm Flange O.D.
Dacromet Finish Push On Type Retainers
G.M. # 11501849

50 Pcs.

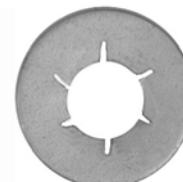

Nuts

Nuts Push On Threaded Stud

1044PK 12-1.75mm Bolt Size
21.4mm Flange O.D.
Black Finish Push On Type Retainers

50 Pcs.



991PK 1/2"-13 Bolt Size
15/16" Flange O.D.
Black Finish Push On Type Retainers

100 Pcs.



Nuts Thread Cutting

265PK 1/8" Stud Size 5/16" Hex Size
17/32" Flange
Zinc Finish Thread Cutting Nuts

100 Pcs.



263PK 3/16" Stud Size 3/8" Hex Size
5/8" Flange Size
Zinc Finish Thread Cutting Nuts

100 Pcs.

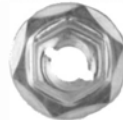

1041PK 5mm Stud Size 10mm Hex Size
15mm Flange Size
Black Finish Thread Cutting Nuts
G.M. # 11501835, 11508900, 10062, 11501932

50 Pcs.



9226PK 1/4" Stud Size 7/16" Hex Size
11/16" Flange Size
Zinc Finish Thread Cutting Nuts

100 Pcs.

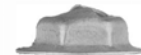
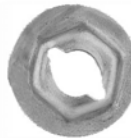

1042PK 6.3mm Stud Size 11mm Hex Size
18mm Flange Size
Zinc Finish Thread Cutting Nuts
G.M. # 11501836

50 Pcs.



856PK 5/16" Stud Size 1/2" Hex Size
7/8" Flange Size
Zinc Finish Thread Cutting Nuts

50 Pcs.



Nuts Hex Flange

5797PK 5 - .80mm 8mm Hex Size
11.8mm O.D. Washer
Black Finish Metric Hex Flange Nuts
G.M. # 11502722, 11502702

50 Pcs.



5800PK 6-1.00mm 10mm Hex Size
16mm O.D. Serrated Washer
Black Finish Metric Hex Flange Nuts

100 Pcs.

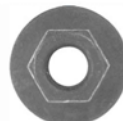

Nuts

Nuts Hex Flange

11191PK 8-1.25mm Screw Size 13mm Hex Size
17mm O.D. Washer
Black Finish Metric Hex Flange Nuts
G.M. # 11501889, 11507036, 11502609

25 Pcs.



5805PK 8 - 1.25mm 13mm Hex Size
19mm O.D. Serrated Washer
Black Finish Metric Hex Flange Nuts

100 Pcs.



1017PK 10-1.50mm 15mm Hex Size
21mm O.D. Washer
Black Finish Metric Hex Flange Nuts
G.M. # 11501850

25 Pcs.



Nuts Hex Loose Washer

1639PK 5-.80mm 10mm Hex Size
15mm O.D. Loose Washer
Black Finish Metric Hex Nuts
Ford # N621903-S61, 11504614

50 Pcs.



5910PK 6-1.00mm 10mm Hex Size
16mm O.D. Loose Barbed Washer
Black Finish Metric Hex Nuts
G.M. # 11505329, 11503752
Volkswagen # N90100001

25 Pcs.

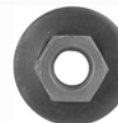

5915PK 6 - 1.00mm 10mm Hex Size
19mm O.D. Loose Barbed Washer
Black Phosphate Finish Metric Hex Nuts
G.M. # 11503754, 11503756, 11505214
Chrysler # 6100049

25 Pcs.



5916XP 8 - 1.25mm 13mm Hex Size
24mm O.D. Loose Barbed Washer
Black Finish Metric Hex Nuts
G.M. # 11503695, 11500401 Ford # N621940

25 Pcs.

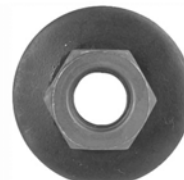

Nuts "U" Type Speed

11040PK #8 Screw Size .045" - .062" Panel Range
3/8" Center Of Hole To Edge
Black Finish "U" Type Speed Nuts
G.M. # 445429, 9422552

50 Pcs.



11136PK #8 Screw Size .025" - .125" Panel Range
3/8" Center Of Hole To Edge
Black Finish "U" Type Speed Nuts

25 Pcs.



Nuts "U" Type











9892PK #6 Screw Size .025" - .125" Panel Range
3/8" Center of Hole to Edge
Black Finish Wide Range "U" Nuts

50 Pcs.















Nuts

Nuts "U" Type

1350PK	#8 Screw Size .020" - .150" Panel Range 3/8" Center of Hole to Edge Black Finish Wide Range "U" Nuts G.M. # 9424837	100 Pcs.		
5750PK	#8 Screw Size .025" - .150" Panel Range 5/8" Center of Hole to Edge Black Finish Wide Range "U" Nuts G.M. # 9440178, 9433155, 11504531 Ford # 381863-S2	100 Pcs.		
5751PK	#10 Screw Size .025" - .150" Panel Range 1 1/32" Center of Hole to Edge Black Finish Wide Range "U" Nuts	25 Pcs.		
5752PK	#10 Screw Size .025" - .150" Panel Range 19/32" Center of Hole to Edge Black Phosphate Finish Wide Range "U" Nuts	50 Pcs.		
1192PK	#14 Screw Size Panel Range: .025" - .150" Center of Hole to Edge: 3/8" Black Phosphate Finish Wide Range "U" Nuts G.M. # 9431532	25 Pcs.		

Nuts Extruded "U" Type Standard

938PK	10-24 Screw Size .025" - .125" Panel Range 15/32" Center of Hole to Edge Black Finish Extruded "U" Nuts G.M. # 152273 Chrysler # 149251	50 Pcs.		
2969PK	1/4"- 20 Screw Size .010" - .165" Panel Range 17/32" Center of Hole to Edge Black Finish Extruded "U" Nuts G.M. # 1494252, 1480627 Ford # 45263-S2	25 Pcs.		
5480PK	1/4"- 20 Screw Size .010" - .165" Panel Range 25/32" Center of Hole to Edge Black Finish Extruded "U" Nuts G.M. # 1494257 Ford # 45267	25 Pcs.		
1835PK	5/16"-18 Screw Size .010" - .165" Panel Range 5/8" Center of Hole to Edge Black Finish Extruded "U" Nuts G.M. # 1494253 Chrysler # 3786805	25 Pcs.		
1836PK	5/16"-18 Screw Size .010" - .170" Panel Range 27/32" Center of Hole to Edge Black Finish Extruded "U" Nuts G.M. # 1494258 Ford # 379831-S	25 Pcs.		
5412PK	3/8"-16 Screw Size .035" - .205" Panel Range 3/4" Center of Hole to Edge Black Finish Extruded "U" Nuts G.M. # 1494254, 12337873 Ford # 45265-S2	25 Pcs.		

Nuts

Nuts Extruded "U" Type Standard

5466PK 3/8"-16 Screw Size .035" - .220" Panel Range
1 1/8" Center of Hole to Edge
Black Finish Extruded "U" Nuts
Ford # 45269, 45269-S



Nuts Extruded "U" Type Metric

5596PK 6 - 1.00mm Screw Size .010" - .165" Panel Range
17/32" Center of Hole to Edge
Black Finish Extruded "U" Nuts
G.M. # 11503957, 11503716, 1016937
Ford # N623332, N623332-S2, N623332-S53
Ford # N623332-S100

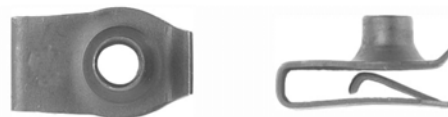

10812PK 6 - 1.00mm .010" - .165" Panel Range
25/32" Center of Hole to Edge
Black Phosphate Finish Extruded "U" Nuts
G.M. # 11503715, 11506099, 11508241



5559PK 6.3 - 1.00mm Screw Size .010" - .165" Panel Range
17/32" Center of Hole to Edge
Black Finish Extruded "U" Nuts
G.M. # 11500658, 9433043, 11502785



5560PK 8 - 1.25mm Screw Size .010" - .165" Panel Range
9/16" Center of Hole to Edge
Black Finish Extruded "U" Nuts
G.M. # 11500660, 11508925, 11502617
Ford # N623333-S2, N623333-S100



10815PK 8 - 1.25mm Screw Size .010" - .175" Panel Range
13/16" Center of Hole to Edge
Black Phosphate Finish Extruded "U" Nuts
G.M. # 11500661, 11503317
Ford # N623343-S100, N623343-S2E45



5558PK 10 - 1.50mm Screw Size .035" - .232" Panel Range
3/4" Center of Hole to Edge
Black Finish Extruded "U" Nuts
G.M. # 11500662, 22531616

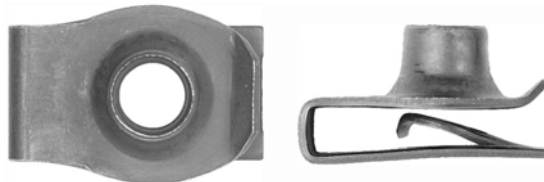

Nuts "U" Type Nylon

1601PK #10 Screw Size Up to 1mm Panel Range
11mm Center of Hole to Edge
Black Nylon "U" Type Retainers
Toyota # 53879-14010-A, 53879-14020



Nuts Nylon

9111PK #6 (3.5mm) Screw Size 10mm Head 8.5mm Stem
6.5mm x 7.5mm Hole Size
Natural Nylon Headlight Screw Grommets
G.M. # 380382 AMC # 400141
Mitsubishi # MS480001



























9591PK #6 (3.5mm) Screw Size 14mm Head 10mm Stem
7mm Hole Size
Natural Nylon With Sealer Screw Grommets
Honda # 90662-693-0030, 90662-693-003
Toyota # 90189-04066





Nuts

Nuts Nylon





1636PK	#6 (3.5mm) Screw Size 14.5mm Head 15mm Stem 7mm Hole Size Natural Nylon Screw Grommets Honda # 90672-671-8110M1 Toyota # 90189-04013	25 Pcs.		
1577PK	#8 (4.2mm) Screw Size 10mm Head 6.5mm Stem 6mm Hole Size Natural Nylon Side Marker Light Screw Grommets Datsun # 97606-B0700 Honda # 75522-611-000 Honda # 75522-611-0000 Mazda # 9991-00-412 Mitsubishi # MS-480001 Nissan # 96706-B0700 Toyota # 90189-04042, 95900-04036	50 Pcs.		
2940PK	#8 (4.2mm) Screw Size 31/64" Head 17/64" Stem 5/16" Hole Size Natural Nylon Headlamp Screw Grommets G.M. # 14013246	50 Pcs.		
9050PK	#8 (4.2mm) Screw Size 17/32" Head 17/64" Stem 11/32" Hole Size Natural Nylon Grille Screw Grommets G.M.	50 Pcs.		
1574PK	#8 (4.2mm) Screw Size 7/16" Head 9/32" Stem 5/16" Hole Size Natural Nylon Grille Screw Grommets G.M. # 3919773	100 Pcs.		
2980PK	#8 (4.2mm) Screw Size 7/16" Head 9/32" Stem 5/16" Hole Size Natural Nylon Grille Screw Grommets G.M. # 3893980, 347347	50 Pcs.		
1842PK	#8 (4.2mm) Screw Size 3/8" Head 13/32" Stem 1/4" Hole Size Natural Nylon Grille Screw Grommets Ford # 379830-S	50 Pcs.		
1572PK	#8 (4.2mm) Screw Size 16mm Head 17mm Stem 8mm Hole Size Natural Nylon Screw Grommets Honda # 90661-SC7-0030 Mazda # H001-50-841, 74798-S90000 Mitsubishi # MS-480012 Nissan # 01651-00481 Toyota # 90189-06042	25 Pcs.		
1614PK	#10 (4.8mm) Screw Size 13mm Head 8mm Stem 8.5mm Hole Size Natural Nylon Screw Grommets Honda # 75521-611-0000, 91619-SA5-003 Mazda # 9991-00-601 Nissan # 96706-P0105 Toyota # 90189-06010	25 Pcs.		
1296PK	#10 (4.8mm) Screw Size 16.5mm Head 8mm Stem 8mm x 8.5mm Hole Size Natural Nylon Screw Grommets Honda # 90662-671-0030 Mazda # 9991-00-503 Nissan # 68425-H5000	25 Pcs.		
1560PK	#10 (4.8mm) Screw Size 12mm Head 11mm Stem 8mm x 9mm Hole Size Natural Nylon Grille Screw Grommets G.M. # 94841764 Mitsubishi # MS480002 Toyota # 90189-05013	50 Pcs.		
1576PK	#10 (4.8mm) Screw Size 18mm Head 17mm Stem 8.5mm Hole Size Natural Nylon Screw Grommets Mitsubishi # MB-098145 Nissan # 01281-00023 Toyota # 90189-06001, 96706-U0100	25 Pcs.		

Nuts

Nuts Nylon









11389PK	#12 (5.5mm) Screw Size 20mm Head 18mm Stem 9mm Hole Size Black Nylon Hood & Fender Screw Grommets Toyota # 90189-06065	15 Pcs.		
9912PK	#12 (5.5mm) Screw Size 16mm Head 19mm Stem 9mm Hole Size Black Nylon Front & Rear Wheel Fender Liner Screw Grommets Toyota # 90189-06028	15 Pcs.		
1228PK	#14 (6.3mm) Screw Size 5/8" Head 5/16" Stem 13/32" Hole Size White Plastic License Plate Nuts G.M. # 4755299, 3907444, 379046-S	50 Pcs.		
1605PK	#14 (6.3mm) Screw Size 20mm Head 17mm Stem 8mm Hole Size Black Nylon Screw Grommets Toyota # 90189-06013, 96706-W100	25 Pcs.		
9913PK	#12 (5.5mm) Screw Size 20mm Head 22mm Stem 8mm Hole Size Black Nylon Front & Rear Wheel Fender Liner Screw Grommets Toyota # 90189-06157	15 Pcs.		

Nuts Rubber Well

11284PK	1/4-20 Screw Size 17/32" Head 5/8" Stem 3/8" Hole Size Black Rubber Well Nuts G.M. # 12338025	10 Pcs.		
1095PK	1/4-20" Screw Size 5/8" Head 9/16" Stem 1/2" Hole Size Black Rubber Well Nuts G.M. # 528846, 342271 Chrysler # 2094869, 6033705 AMC # 4003120	25 Pcs.		





















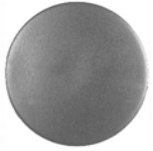

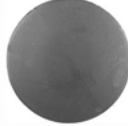
Retainers

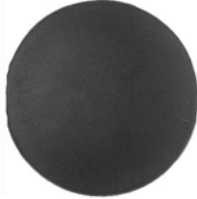
Retainers Christmas Tree

JL-24PK	7/64" (2.5mm) Hole Size 25/64" Stem 7/32" Head .069" - .250" Panel Range Black Nylon Shield Retainers G.M. # 20729523	100 Pcs.		
5605PK	3/16" (4.5mm) Hole Size 21/64" Stem 7/16" Head .080" - .200" Panel Range Black Nylon Weatherstrip Retainers G.M. # 10169777	25 Pcs.		
5602PK	5/32" (4mm) Hole Size 7/16" Stem 23/64" Head .030" - .275" Panel Range Black Nylon Shield Retainers G.M. # 10063599	100 Pcs.		
JL-32PK	3/16" (4.5mm) Hole Size 17/32" Stem 3/8" Head .125" - .310" Panel Range Black Nylon Weatherstrip Retainers G.M. # 2964547	25 Pcs.		















Retainers

Retainers Christmas Tree

9178PK	3/16" (4.5mm) Hole Size 1/2" Stem Length 7/16" Head Diameter Black Nylon Facia Shield Retainers Ford # N803170-S	25 Pcs.		
8172PK	3/16" (4.5mm) Hole Size 21/32" Stem 7/16" Head .060" - .390" Panel Range Black Nylon Dash Panel Retainers G.M. # 25016383, 20413107 Ford # 388246A AMC # 4006516	50 Pcs.		
1583PK	3/16" (5mm) Hole Size 3/4" Stem 19/32" Head .70" - .555" Panel Range Black Nylon Shroud Vent Grille To Panel Ret. G.M. # 20514862	50 Pcs.		
JL-23PK	13/64" (5.3mm) Hole Size 11.5mm Stem 10mm Head .030" - .285" Panel Range Black Nylon Weatherstrip Retainers G.M. # 20699808 Chrysler # 6502328	50 Pcs.		
5609PK	13/64" (5.3mm) Hole Size 5/8" Stem 19/32" Head .030" - .365" Panel Range Black Nylon Weatherstrip Retainers G.M. # 10293674 Chrysler # 4658673	50 Pcs.		
JL-26PK	13/64" (5.3mm) Hole Size 11/16" Stem 3/4" Head .065" - .515" Panel Range Blue Nylon Shield Retainers Ford # N8010994S	50 Pcs.		
5610PK	7/32" (5.5mm) Hole Size 3/4" Stem 21/32" Head .060" - .565" Panel Range Black Nylon Shield Retainers Chry. # 6501948	50 Pcs.		
5614PK	7/32" (5.5mm) Hole Size 25/32" Stem 1" Head .080" - .545" Panel Range Black Nylon Shield Retainers Ford # N808370-S	50 Pcs.		
5618PK	15/64" (6mm) Hole Size 1/2" Stem 15/32" Head .035" - .285" Panel Range Black Nylon Shield Retainers G.M. # 20709017	50 Pcs.		
10568PK	15/64" (6mm) Hole Size 33mm Stem Length 18mm Head Diameter Black Nylon Wheel Well Shield Retainers G.M. # 11588950 Ford # W709002, W709002-SAA	25 Pcs.		
10064PK	1/4" (6.3mm) Hole Size 45mm Stem 18mm Head .120" - 1.575" Panel Range Black Nylon Mud Flap Retainers Ford # W707889-S300	25 Pcs.		

Retainers

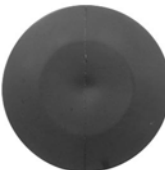
Retainers Christmas Tree

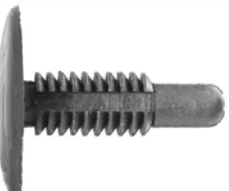
5429PK	1/4" (6.4mm) Hole Size 21/32" Stem 11/16" Head .115" - .400" Panel Range Black Nylon Fender & Bumper Sheild Retainers G.M. # 332364, 14093311, 20732399 Ford # 389358 Chrysler # 3691590 Chrysler # 6031321 AMC # 4004569	100 Pcs.		
5506PK	1/4" (6.4mm) Hole Size 23/32" Stem 1/2" Head .110" - .460" Panel Range Black Nylon Trim Panel Retainers G.M. # 411700	50 Pcs.		
5625PK	1/4" (6.4mm) Hole Size 13/16" Stem 23/32" Head .095" - .540" Panel Range Black Nylon Fender & Bumper Shield Retainers G.M. # 1605396, 11569768 Ford # 388577S, 389358S, 6036007AA, W705589-S300 Chrysler # 15958694, 6502078, 3691590, 6030441 AMC # 4004919	100 Pcs.		
5632PK	1/4" (6.4mm) Hole Size 25/32" Stem 1" Head .070" - .590" Panel Range Black Nylon Fascia Panel Retainers Chrysler # 6501067	50 Pcs.		
9130PK	1/4" (6.4mm) Hole Size 1 1/16" Stem 23/32" Head .095" - .805" Panel Range Black Nylon Engine Splash Shield Retainers G.M. # 10121502, 10077401, 6033082 Ford # W709346-S300, 390018-S	50 Pcs.		
5628PK	1/4" (6.4mm) Hole Size 1 1/16" Stem Length 1" Head Diameter Black Nylon Shield Retainers Chrysler # 6502104	25 Pcs.		
10366PK	1/4"(6.4mm) Hole Size 1 7/16" Stem Length 7/8" Head Diameter Black Nylon Splash Shield & Wheel Cover Retainers G.M. # 22547243 Chrysler # 6501916	50 Pcs.		
5627PK	1/4" (6.4mm) Hole Size 1 3/32" Stem Head 1 .100" - .685" Panel Range Black Nylon Trim Panel Retainers Ford # 388930-S Ford # 391039-S	50 Pcs.		









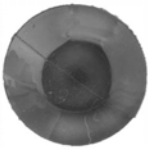

Retainers

Retainers Christmas Tree





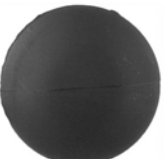





9374PK	17/64" (7mm) Hole Size 15/64" Stem Length 25/32" Head Diameter Black Nylon Seat BackShield Retainers G.M. # 20319841	25 Pcs.	
5635PK	9/32" (7.1mm) Hole Size 20mm Stem 25mm Head 2.56mm - 12.96mm Panel Range Black Nylon Interior Trim Retainers G.M. # 22718305 Ford # N802734S Chrysler # 6506788	50 Pcs.	
9849PK	9/32" (7.1mm) Hole Size 27/32" Stem 1" Head .106 - .540" Panel Range Black Nylon Fascia Panel Retainers Ford # 389443-S	25 Pcs.	
9132PK	9/32" (7.1mm) Hole Size 1 11/64" Stem 3/4" Head .055" - 1.00" Panel Range Black Nylon Bumper Fascia Retainers G.M. # 10185925	25 Pcs.	
2048PK	9/32" (7.1mm) Hole Size 38.5mm Stem 26mm Head .075" - 1.25" Panel Range Black Nylon Interior Trim Retainers Ford # N804349S	25 Pcs.	
JL-120PK	9/32" (7.1mm) Hole Size 1 3/4" Stem 1" Head .075" - 1.510" Panel Range Black Nylon Trim Panel Retainers Ford # E7EB5802354AAJABH	25 Pcs.	
5640PK	5/16" (7.8mm) Hole Size 19/32" Stem 33/64" Head .080" - .270" Panel Range Black Nylon Panel Retainers Chrysler # 34202335	25 Pcs.	
JL-33PK	5/16" (7.8mm) Hole Size 31/32" Stem 3/4" Head .145" - .530" Panel Range Black Nylon Trim Panel Retainers G.M. # 21094146, 21110201 Chrysler # 6501301	25 Pcs.	
8862BPK	5/16" (7.8mm) Hole Size 1 1/16" Stem 3/4" Head .090" - .815" Panel Range Black Nylon Shield Retainers G.M. # 15975244	25 Pcs.	

Retainers

Retainers Christmas Tree















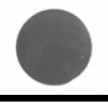

5995PK	5/16" (7.8mm) Hole Size 1 7/16" Stem 3/4" Head .055" - 1.05" Panel Range Black Nylon Hood Seal Retainers G.M. # 14074081, 15552345, 1699250	25 Pcs.		
5643PK	23/64" (9mm) Hole Size 19.5mm Stem 16mm Head .060" - .510" Panel Range Black Nylon Trim Panel Retainers Ford # N807721-S Chrysler # 6504043, 650403	50 Pcs.		
9352PK	3/8" (9.5mm) Hole Size 57/64" Stem Length 7/8" Head Diameter Black Nylon Front End Stone Shield Retainers G.M. # 22512276 Chrysler # 6503221	25 Pcs.		
5710PK	3/8" (9.5mm) Hole Size 27/32" Stem 1" Head .115" - .565" Panel Range Black Nylon Radiator Apron Panel Retainers G.M. # 1619321	25 Pcs.		
5648PK	25/64" (10mm) Hole Size 30mm Stem 22mm Head .040" - .790" Panel Range Black Nylon Fascia Bumper Retainers G.M. # 1631564 Ford # N804379S Chrysler # 34202787 Nissan # 63844-01A00	50 Pcs.		

Retainers Weatherstrip

1991PK	3/16" (4.5mm) Hole Size 12mm Stem Length 4.75mm x 13.5mm Head Dia. Black Nylon Weatherstrip Retainers G.M. # 4876498	100 Pcs.		
9560PK	13/64" (5mm) Hole Size 10mm Stem Length 7mm x 16mm Head Diameter Natural Nylon Weatherstrip Retainers Datsun # 80833-8500, 8083265000 Honda # 90664-671-0030	50 Pcs.		
9208PK	15/64" (6mm) Hole Size 10mm Stem Length 5mm x 15mm Head Diameter Orange Nylon Weatherstrip Retainers Honda # 91530-SP1-003, W704643 Honda # 91530-SPL-003 Ford # N807438S	25 Pcs.		
2016PK	13/64" (5mm) Hole Size 10.5mm Stem Length 6.5mm x 16.5mm Head Dia. White Nylon Weatherstrip Retainers G.M. # 21097292, 21077575, Chrysler # 4696129	50 Pcs.		
9264PK	15/64" (6mm) Hole Size 12.3mm Stem Length 5.25mm x 14.2mm Head Dia. Black Nylon Weatherstrip Retainers Ford	50 Pcs.		

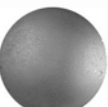
Retainers

Retainers Panel

















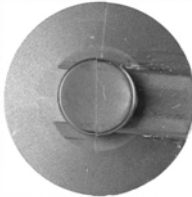

9074PK	13/64" (5mm) Hole Size 14mm Head 10mm Stem 3mm Panel Thickness Black Nylon Panel Retainers Toyota # 90467-06161-01	25 Pcs.		
1996PK	13/64" (5mm) Hole Size 13mm Head 11mm Stem Black Nylon Hood Seal Retaining Clips Toyota # 90467-08004, 90467-08011	50 Pcs.		
1466PK	13/64" (5mm) Hole Size 13mm Head 15mm Stem Black Nylon Retaining Clips Nissan # 01553-00172 Toyota # 90467-07050	25 Pcs.		
9554PK	13/64" (5mm) Hole Size 13mm Head 15mm Stem 4mm Panel Thickness Black Nylon Retaining Clips Honda # 90687-SA5-0030	50 Pcs.		
5606PK	15/64" (6mm) Hole Size 10mm Head 10mm Stem 4mm Panel Range Black Nylon Hood Moulding Retainers Honda # 91520-SM4-C010, 91520-SM4-C01	25 Pcs.		
9262PK	15/64" (6mm) Hole Size 12mm Head 9mm Stem 9mm Panel Range Black Nylon Hood & Trunk Moulding Retainers Honda # 91518-SM4-003	10 Pcs.		
1634PK	15/64" (6mm) Hole Size 14mm Head 16mm Stem 5mm Panel Thickness Black Nylon Retaining Clips Honda # 90467-11005 Isuzu # 89421-76980 Mazda # 9926-40-658 Nissan # 76906-T3000, 76916-T3000 Toyota # 90467-09069-06-21, 90467-09069-06-20	50 Pcs.		
11387PK	5/16" (8mm) Hole Size 15/32" Stem Length 3/4" Flange Diameter White Nylon Exterior Moulding Retainers Ford	10 Pcs.		

Retainers Push Type

1756PK	15/64" (6mm) Square Hole Size 8mm Stem Length 8mm x 12mm Flange Diameter Black Nylon Cowl Grille Push Type Retainers Nissan # 66814-01G00	25 Pcs.		
9617PK	15/64" (6mm) Hole Size 16mm Stem Length 17mm Flange Diameter Black Nylon Radiator & Fender Push Type Retainers G.M. # 15149708	25 Pcs.		
10424PK	1/4" (6.3mm) Hole Size 7/16" Stem Length 5/8" Flange Diameter Black Nylon Headlight Bracket Push Type Retainers Ford # 383142-S	50 Pcs.		



















Retainers

Retainers Push Type

5675PK	1/4" (6.4mm) Hole Size 9/16" Stem 11/16" Flange 9/16 Panel Range Black Nylon Fender & Mud Skirt Push Type Retainers G.M. # 14019205, 14019206 Ford # E308-4A163CA Chrysler # 34201621, 06504090 AMC # 8934-201-621 AMC/Jeep # 6503454	50 Pcs.		
11137PK	1/4" (6.3mm) Hole Size 17mm Stem Length 20mm Flange Diameter Black Nylon Retainers Push Type Bumper Trim BMW # 51-11-8-174-185	25 Pcs.		
9559PK	1/4" (6.4mm) Hole Size 3/4" Stem Length 19/32" Flange Diameter Black Nylon Wheel Moulding Push Type Retainers G.M. # 21077123, 20730531 Ford # W705436-F300	25 Pcs.		
9369PK	1/4"(6.4mm) Hole Size 29/32" Stem Length 11/16" Flange Diameter Black Nylon Exterior Body Push Type Retainers G.M. # 20590899, 20510029 Ford # N803362-S Chrysler # 4857136, 34202672	25 Pcs.		
5935PK	1/4" (6.4mm) Hole Size 1" Flange 29/32" Stem .098" - .350" Panel Range Black Nylon Splash Shield Push Type Retainers G.M. # 14093088 Ford # 802781-S, W704340-S300, 802781-S	25 Pcs.		
10368PK	17/64" (6.5mm) Hole Size 17.5mm Stem 18mm Flange 2mm - 4.5mm Panel Range Black Nylon Push Type Retainers G.M. # 11589289 Chrysler # 6508863AA	25 Pcs.		
10369PK	17/64" (6.5mm) Hole Size 20mm Stem 18mm Flange 4.5mm - 7mm Panel Range Black Nylon Push Type Retainers G.M. # 11589290	50 Pcs.		
10367PK	17/64" (6.5mm) Hole Size 22mm Stem 14mm Flange 7mm - 9.5mm Panel Range Black Nylon Push Type Retainers G.M. # 11589291 Ford # W713331-S300	25 Pcs.		
10450PK	17/64" (7mm) Hole Size 7.5mm Stem Length 18mm Flange Diameter Black Nylon Front Fender Liner Push Type Retainers G.M.# 88970767 Toyota # 90467-10183	10 Pcs.		











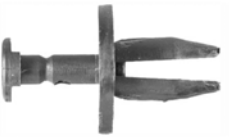



Retainers

Retainers Push Type

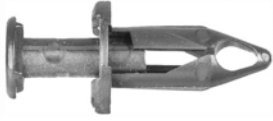
9465PK	17/64" (7mm) Hole Size 10mm Stem Length 20mm Flange Diameter Black Nylon Front Fender Liner Push Type Retainers Toyota # 90467-07166	15 Pcs.		
10435PK	17/64" (7mm) Hole Size 14mm Stem Length 30mm Head Diameter Black Nylon Hood Insulation Retainers Honda # 91501-S1K-003	25 Pcs.		
10569PK	17/64" (7mm) Hole Size 10mm Stem Length 20mm Flange Diameter Black Nylon Engine Under Cover Push Type Retainers Toyota # 90467-07201	10 Pcs.		
10570PK	17/64" (7mm) Hole Size 10mm Stem Length 20mm Flange Diameter Black Nylon Fender Splash Shield Push Type Retainers Toyota # 90467-07164	10 Pcs.		
9114PK	17/64" (7mm) Hole Size 16mm Stem Length 18mm Flange Diameter Black Nylon Push Type Retainers Nissan # 80999-05N07, 01553-00755 Toyota # 90467-07043, 90467-07043-C0	25 Pcs.		
10536PK	5/16" (8mm) Hole Size 10mm Stem Length 18mm Flange Diameter Black Nylon Bumper Clip Push Type Retainers Nissan # 01553-09611	15 Pcs.		
9292PK	5/16" (8mm) Hole Size 10mm Stem Length 20mm Flange Diameter Black Nylon Front Fender Push Type Retainers Honda # 91501-S04-003	15 Pcs.		
2128PK	5/16" (8mm) Hole Size 11mm Stem Length 20mm Flange Diameter Black Nylon Fender & Bumper Push Type Retainers Acura # 91512-SX0-003 Mitsubishi # MU000319	25 Pcs.		
9540PK	5/16" (8mm) Hole Size 13mm Stem Length 20mm Flange Diameter Black Nylon Push Type Retainers Chrysler # MR3289541 Nissan # 01553-09321, 01553-0932	15 Pcs.		

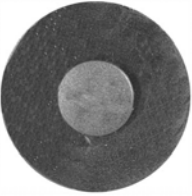
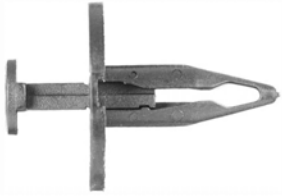

















Retainers

Retainers Push Type

5676PK	5/16" (8mm) Hole Size 13.5mm Stem Length 17mm Flange Diameter Black Nylon Radiator Push Type Retainers G.M. # 14071289, 14019226 Ford # 04388293 Chrysler # 175720B010	25 Pcs.		
1949PK	5/16" (8mm) Hole Size 15mm Stem Length 20mm Flange Diameter Black Nylon Front & Rear Bumper Push Type Retainers Nissan # 01553-06721	15 Pcs.		
10370PK	5/16" (8mm) Hole Size 16mm Stem 19mm Flange 5mm - 7mm Panel Range Black Nylon Push Type Retainers G.M. # 15296830 Chrysler # 5116530AA	25 Pcs.		
1975PK	5/16" (8mm) Hole Size 20mm Stem Length 16mm Flange Diameter Black Nylon Body Side Mldg. Push Type Retainers Nissan # 76882-57A00	25 Pcs.		
1861PK	5/16" (8mm) Hole Size 20mm Stem Length 15mm Flange Diameter Black Nylon Rocker Panel Retainers G.M. # 21075686 Ford # F3LB-14K056-AA Chrysler # 6504555	25 Pcs.		
1860PK	5/16" (8mm) Hole Size 20mm Stem Length 20mm Flange Diameter Black Nylon Air Baffle Push Type Retainers G.M. # 21030249, 15969147 Ford # N807389S, 807389S Chrysler # 6503598	25 Pcs.		
5940PK	5/16" (8mm) Hole Size 25mm Flange 23mm Stem 3.5mm - 7.9mm Panel Range Black Nylon Splash Shield Push Type Retainers G.M. # 20570245 Ford # N804614S, N803934-S, W701054-5300	25 Pcs.		
1263PK	5/16" Hole Size 29/32" Stem Length 1" Flange 7/64" Shoulder Black Nylon Splash Shield & Fascia Push Type Retainers Ford # N803421-S Chrysler # 6500725	25 Pcs.		
2133PK	5/16" (8mm) Hole Size 23mm Stem Length 18mm Flange Diameter Black Nylon Fascia Push Type Retainers Chrysler # 6504521	25 Pcs.		















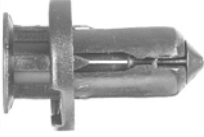

Retainers

Retainers Push Type

10075PK	5/16" (8mm) Hole Size 19mm Stem Length 18mm Flange Diameter Black Nylon Garnish Side Protector Push Type Retainer Honda # 90505-SX0-003	15 Pcs.		
10504PK	5/16" (8mm) Hole Size 26mm Stem Length 20mm Flange Diameter Black Nylon Fender Shield Push Type Retainers G.M. # 11518017 Ford # W708530-S300	15 Pcs.		
10239PK	21/64" (8.5mm) Hole Size 14mm Stem 19mm Flange 2.7mm - 5.3mm Panel Range Black Nylon Push Type Retainers G.M. # 11609417	50 Pcs.		
10371PK	21/64" (8.5mm) Hole Size 20.5mm Stem 20mm Flange 2mm - 4.5mm Panel Range Black Nylon Push Type Retainers G.M. # 11589292	25 Pcs.		
10374PK	21/64" (8.5mm) Hole Size 22mm Stem 20mm Flange 4.5mm - 7mm Panel Range Black Nylon Push Type Retainers G.M. # 11589293 Ford # W712196S300	25 Pcs.		
10372PK	21/64" (8.5mm) Hole Size 24mm Stem 20mm Flange 7mm - 10mm Panel Range Black Nylon Push Type Retainers G.M. # 11589294	25 Pcs.		
9943PK	23/64" (9mm) Hole Size 13mm Stem Length 18mm Flange Diameter Black Nylon Fender & Bumper Push Type Retainers Mitsubishi # MR200300	15 Pcs.		
10356PK	23/64" (9mm) Hole Size 22mm Stem Length 18mm Flange Diameter Black Nylon Bumper Fascia Retainers Nissan # 63848-9E001	10 Pcs.		
9327PK	11/32" (9mm) Hole Size 28mm Stem Length 18mm Flange Diameter Black Nylon Rear Bumper Cover Push Type Retainers Toyota # 52161-16010, 52161-02020	4 Pcs.		

Retainers

Retainers Push Type

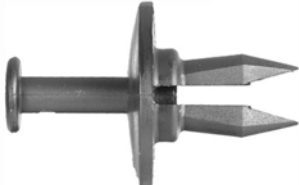
5677PK	3/8" (9.5mm) Hole Size 11/16" Stem Length 1" Flange Diameter Black Nylon Fascia Push Type Retainers G.M. # 14045480 Chrysler # 55074801	25 Pcs.		
10375PK	3/8" (9.5mm) Hole Size 20mm Stem 18mm Flange 2.95mm - 5.75mm Panel Range Black Nylon Push Type Retainers G.M. # 11561368 Chrysler # 6508712AA	25 Pcs.		
9370PK	3/8" (9.5mm) Hole Size 23mm Stem Length 18mm Flange Diameter Black Nylon Front Bumper Fascia Retainers G.M. # 10157900	25 Pcs.		
9294PK	25/64" (10mm) Hole Size 15mm Stem Length 18mm Flange Diameter Black Nylon Push Type Retainers Nissan # 01553-09241 Subaru # 57728AC090	15 Pcs.		
9282PK	25/64" (10mm) Hole Size 16mm Stem Length 20mm Flange Diameter Black Nylon Front Bumper Push Retainers Acura # 91503-SZ3-003	15 Pcs.		
9382PK	25/64" (10mm) Hole Size 18mm Stem Length 20mm Flange Diameter Black Nylon Front & Rear Bumper Push Type Retainers Honda # 91503-SZ5-003	15 Pcs.		
10377PK	13/32" (10.5mm) Hole Size 20mm Stem 25mm Flange 3mm - 6mm Panel Range Black Nylon Push Type Retainers G.M. # 11589295 Chrysler # 5GUU9K111BA	15 Pcs.		
10378PK	13/32" (10.5mm) Hole Size 22.5mm Stem 25mm Flange 6mm - 9mm Panel Range Black Nylon Push Type Retainers G.M. # 11589296	15 Pcs.		
5672PK	1/2" (12.7mm) Hole Size 3/4" Stem Length 1" Flange 1/8" Shoulder Black Nylon Fascia Push Type Retainers G.M. # 5973400	25 Pcs.		

Retainers

Retainers Push Type

10382PK 1/2" (12.7mm) Hole Size 1 5/8" Stem Length
1" Flange 9/64" Shoulder
Black Nylon License Plate Push Type Retainers
G.M. # 15959832

5 Pcs.



Retainers Phillips Screw Type

1597PK 15/64" (6mm) Hole Size 11mm Stem Length
15mm Flange Diameter
Black Nylon Phillips Screw Retainers
Honda # 90684-SA5-0030, 90684-SA5-0030
Isuzu # 874-298-1190, 8942981190
Nissan # 10998-30880

25 Pcs.



2028PK 15/64" (6mm) Hole Size 16mm Stem Length
14mm Flange Diameter
Black Nylon Engine Splash Phillips Screw Retainer
G.M. # 94051993 Nissan # 66860-01W01

25 Pcs.



9968PK 1/4" (6.3mm) Hole Size 29/32" Stem Length
5/8" Flange Diameter
Black Nylon Phillips Screw Retainers
G.M. # 20664091 Ford # N803946S
Chrysler # 6502871

50 Pcs.



9067PK 1/4" (6.3mm) Hole Size 29/32" Stem Length
11/16" Flange Diameter
Black Nylon Radiator Shroud Phillips Screw Retainers
G.M. # 22538004, 20664092 Ford # N804570S
Chrysler # 6502790

25 Pcs.



2015PK 17/64" (7mm) Hole Size 11mm Stem Length
14mm Flange Diameter
Black Nylon Phillips Screw Retainers
G.M. # 94198687 Honda # 90657-SA6-0030
Mazda # N304-13-356-A

25 Pcs.



1603PK 9/32" (7mm) Hole Size 12mm Stem Length
15mm Flange Diameter
Black Nylon Phillips Screw Retainers
Toyota # 90467-06017, 90467-06017-20
Mazda # 9926-50-625

15 Pcs.



5920PK 5/16" (8mm) Hole Size 9mm Stem Length
20mm Flange Diameter
Black Nylon Splash Shield Phillips Screw Retainers
Honda # 90675-SB3-003, 90675-SB0-003
Nissan # 63876-95596, 63876-D5596
Mazda # FB01-56-964

25 Pcs.



1976PK 5/16" (8mm) Hole Size 9mm Stem Length
20mm Flange Diameter
Black Nylon Fender Splash Phillips Screw Retainers
Honda # 91512-SM4-003

10 Pcs.























9287PK 5/16" (8mm) Hole Size 12mm Stem Length
18mm Flange Diameter
Black Nylon Phillips Screw Retainers
Ford # MB-455-56143 Hyundai # 86590-28000
Mazda # B092-51-833

10 Pcs.



Retainers

Retainers Phillips Screw Type

5901PK	5/16" (8mm) Hole Size 18mm Stem Length 20mm Flange Diameter Black Nylon Inner Fender Phillips Screw Retainers Ford # MNA01-56145, NA01-56145 Nissan # 63844-01A00	25 Pcs.		
1446PK	5/16" (8mm) Hole Size 13/16" Stem Length 19/32" Flange Diameter Black Nylon Phillips Screw Retainers G.M. # 10053182	25 Pcs.		
10538PK	5/16" (8mm) Hole Size 20mm Stem Length 20mm Flange Diameter Black Nylon Front Bumper Fascia Phillips Screw Retainers Mitsubishi # MB547806 Nissan # 63854-01A00	15 Pcs.		
11024PK	5/16" (8mm) Hole Size 22mm Stem Length 20mm Flange Diameter Black Nylon Phillips Screw Retainers Nissan # 6387801E10K0A	15 Pcs.		
1973PK	5/16" (8mm) Hole Size 21mm Stem Length 18mm Flange Diameter Black Nylon Phillips Screw Retainers Honda # 90505-SM4-003, 90505-SM-003	10 Pcs.		
9646PK	11/32" (9mm) Hole Size 26mm Stem Length 20mm Flange Diameter Black Nylon Bumper Cover Phillips Screw Retainers Toyota # 90467-09127	10 Pcs.		
9202PK	25/64" (10mm) Hole Size 15mm Stem Length 20mm Flange Diameter Black Nylon Front & Rear Bumper Phillips Screw Retainers Acura # 91503-SP0-0030 Honda # 91503-SP0-003	15 Pcs.		
D-124PK	25/64" (10mm) Hole Size 24mm Stem Length 20mm Flange Diameter Black Nylon Bumper Fascia Phillips Screw Retainers Honda # 91504-SM4-0000, 91504-SM4-000	10 Pcs.		
2060PK	25/64" (10mm) Hole Size 25mm Stem Length 20mm Flange Diameter Black Nylon Front & Rear Bumper Phillips Screw Retainers Honda # 91502-SP0-003	10 Pcs.		
D-123PK	25/64" (10mm) Hole Size 28mm Stem Length 20mm Flange Diameter Black Nylon Bumper Fascia Phillips Screw Retainers Honda # 91502-SM4-0000, 91502-SM4-000	10 Pcs.		

Retainers

Retainers Phillips Screw Type

2153PK 7/16" (11mm) Hole Size 14mm Stem Length
22mm Flange 3.5mm Shoulder
Black Nylon Bumper & Fascia Phillips Screw
Retainers
Nissan # 01553-03101

15 Pcs.



Hood Insulation Retainers

G.M. Hood Insulation Retainers

2167PK 1/4" (6.3mm) Hole Size 12.5mm Stem Length
30mm Head Diameter
Black Nylon Hood Insulation Retainers
G.M. # 21039129 Chrysler # 6502842

50 Pcs.



1930PK 1/4" (6.4mm) Hole Size 3/4" Stem Length
1 5/8" Head Diameter
Black Nylon Hood Insulation Clips
G.M. # 20064875

25 Pcs.



5440PK 1/4" (6.4mm) Hole Size 3/4" Stem Length
2" Head Diameter
Black Polypropylene Hood Insulation Retainers
G.M. # 3078511, 3977775

25 Pcs.

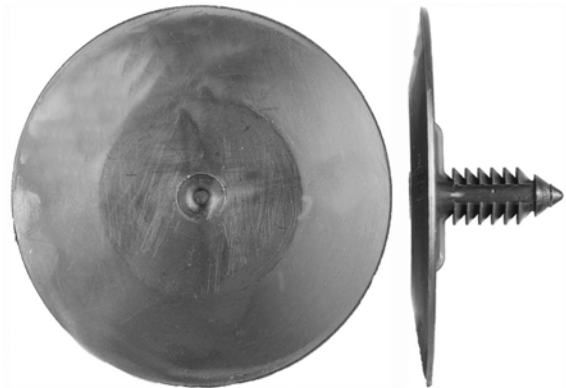

Ford Hood Insulation Retainers

2111PK 1/4" (6.3mm) Hole Size 18mm Stem Length
32mm Head Diameter
Black Nylon Hood Insulation Retainers
Ford # N808842-S Chrysler # 6504098

50 Pcs.



Hood Insulation Retainers

Ford Hood Insulation Retainers

9588PK 1/4" (6.4mm) Hole Size 3/4" Stem Length
1 3/16" Head Diameter
Black Nylon Hood Insulation Retainers
Ford # 386553-S, 385595-S

50 Pcs.



Chrysler Hood Insulation Retainers

639PK 1/4" (6.3mm) Hole Size 1/2" Stem Length
1 1/4" Head Diameter
Black Nylon Radiator Grille Retainers
Chrysler #2998430

25 Pcs.



9980PK 1/4" (6.3mm) Hole Size 13mm Stem Length
30mm Head Diameter
Black Nylon Hood Insulation Retainers
Chrysler # 4878883AA

50 Pcs.



1865PK 1/4" (6.4mm) Hole Size 13/16" Stem Length
1 5/16" Head Diameter
Black Nylon Hood Insulation Retainers
Chrysler # 4341060

25 Pcs.

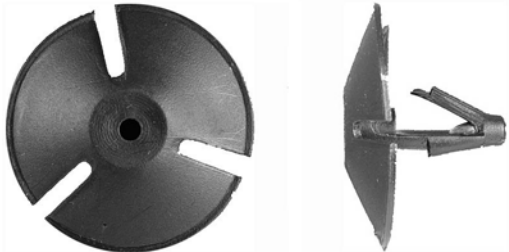

Acura Hood Insulation Retainers

9945PK 9/32" (7.5mm) Hole Size 10mm Stem Length
30mm Head Diameter
Black Nylon Hood Insulation Retainers
Acura # 90700-SJ4-000

15 Pcs.



Hyundai Hood Insulation Retainers

10782PK 5/16" (8mm) Hole Size 14mm Stem Length
26mm Head Diameter
Black Nylon Hood Insulation Retainers
Hyundai # 81126-37010

15 Pcs.



Hood Insulation Retainers

Nissan Hood Insulation Retainers

2025PK 3/16" (5mm) Hole Size 9mm Stem Length
30mm Head Diameter
Black Nylon Hood Insulation Retainers
Nissan # 65846-30F00, 65832-F5000



Toyota Hood Insulation Retainers

10141PK 17/64" (7mm) Hole Size 12mm Stem Length
25mm Head Diameter
Black Nylon Hood Insulation Retainers
Toyota # 90467-09050, 90467-A0003



1950PK 17/64" (7mm) Hole Size 19mm Stem Length
30mm Head Diameter
Black Nylon Hood Insulation Retainers
Toyota # 90467-09008



Door Fasteners

Door Handle Clips

812PK Door Window
Crank Handle
Bright Zinc Finish Retaining Clips



G.M. Door Panel Retainers

1646PK 1/4" (6.5mm) Hole Size 21mm Stem Length
6.3mm x 11.5mm Top Head Dia.
Natural Nylon Door Trim Panel Retainers
G.M. # 15545202



4020PK 1/4" (6.5mm) Hole Size 21mm Stem Length
6.3mm x 11.5mm Top Head Dia.
Natural Nylon Door Trim Panel Retainers
G.M. # 20421800, 15600382

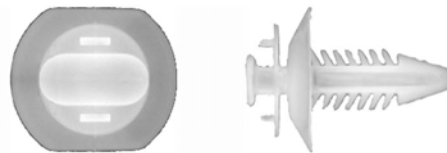



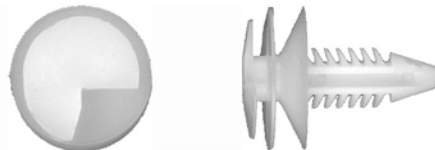





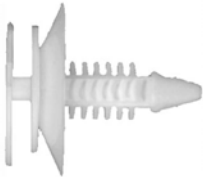



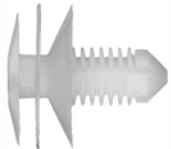



9242PK 1/4" (6.5mm) Hole Size 21mm Stem Length
17mm Top Head Diameter
Natural Nylon Door Trim Panel Retainers
G.M. # 12337920, 20374473



Door Fasteners

G.M. Door Panel Retainers

5264PK	1/4" (6.5mm) Hole Size 29/32" Stem Length 29/32" Top Head Diameter Natural Nylon Door Trim Panel Retainers G.M. # 3065575, 16656935X	50 Pcs.		
2029PK	1/4" (6.3mm) Hole Size 11/16" Stem Length 37/64" Top Head Diameter White Nylon Push Type Door Trim Panel Ret. G.M. # 15960325	50 Pcs.		
592PK	17/64" (7mm) Hole Size 14.8mm Stem Length 17.6mm Top Head Diameter Natural Nylon Door Trim Panel Retainers G.M. # 2064891, 9818648, 9883583	50 Pcs.		
2017PK	17/64" (7mm) Hole Size 16mm Stem Length 14mm Top Head Diameter Black Nylon Door Trim Panel Retainers G.M. # 15638413, 15963179	50 Pcs.		
1024PK	17/64" (7mm) Hole Size 18.5mm Stem Length 20mm Top Head Diameter Natural Nylon Door Trim Panel Retainers G.M. # 9685057 Ford # 385661-S Chrysler # 6003349 AMC 4005470 Volkswagen # N98905101	25 Pcs.		
9339PK	17/64" (7mm) Hole Size 19mm Stem Length 7mm x 12.5mm Top Head Dia. White Nylon Door Trim Panel Retainers G.M. # 15612948, 15607165	25 Pcs.		
9368PK	17/64" (7mm) Hole Size 32mm Stem Length 20mm Top Head Diameter Natural Nylon Door Trim Panel Retainers G.M. # 10126901	50 Pcs.		
11041PK	17/64" (7mm) Hole Size 1 5/32" Stem Length 1/2" Top Head Diameter Natural Nylon Door Trim Panel Retainers G.M. # 15694099	15 Pcs.		
10703PK	5/16" (8mm) Hole Size 14mm Stem Length 13mm Top Head Diameter White Nylon Door Trim Panel Retainers G.M. # 90321122	50 Pcs.		

Door Fasteners

G.M. Door Panel Retainers

10751PK 21/64" (8.5mm) Hole Size 11mm Stem Length
13mm Top Head Diameter
White Nylon Garnish Moulding Retainers
Toyota # 62217-13010

25 Pcs.



10744PK 23/64" (9mm) Hole Size 10mm Stem Length
13mm Top Head Diameter
Natural Nylon Trim Panel Retainers
G.M. # 94530565 Hyundai # 82315-38000

25 Pcs.



10750PK 23/64" (9mm) Hole Size 10mm Stem Length
10mm x 13mm Top Head Dia.
Yellow Nylon Fender Flare Retainers
G.M. # 88969790 Toyota # 75867-21010

25 Pcs.



10752PK 23/64" (9mm) Hole Size 14mm Stem Length
12mm Top Head Diameter
Orange Nylon Cowl Vent & Radiator Support Ret.
Honda # 90602-SAA-003

15 Pcs.



AMC Door Panel Retainers

9373PK 17/64" (7mm) Hole Size 18mm Stem Length
13mm Top Head Diameter
Black Nylon Door Trim Panel Retainers
G.M. # 796255 Chrysler #6033862 AMC # 4005099
Navistar # 0501094C1

25 Pcs.



Ford Door Panel Retainers

2063PK 17/64" (7mm) Hole Size 15mm Stem Length
13mm Top Head Diameter
White Nylon Door Trim Panel Retainers
Chrysler # 6504014, 6503896
Dodge # 6502907, 6542907

50 Pcs.

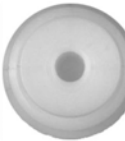

1558PK 17/64" (7mm) Hole Size 19mm Stem Length
13.3mm Top Head Diameter
Natural Nylon Door Trim Panel Retainers
G.M. # 21042958 Ford # N802900

25 Pcs.



2112PK 17/64" (7mm) Hole Size 19mm Stem Length
12.5mm Top Head Diameter
Black Nylon Door Trim Panel Retainers
Ford # N805155-S Chrysler # 6505878AA, 6502709

50 Pcs.



9372PK 5/16" (8mm) Hole Size 21/32" Stem Length
1/2" Top Head Diameter
White Nylon Door Trim Panel Retainers
Ford # 387477-S

50 Pcs.



Door Fasteners

Ford Door Panel Retainers

1575PK 5/16" (8mm) Hole Size 3/4" Stem Length
1/2" Top Head Diameter
Black Nylon Door Trim Panel Retainers
Ford # N801925-S, N801925

25 Pcs.



1742PK 5/16" (8mm) Hole Size 1" Stem Length
1/2" Top Head Diameter
Natural Nylon Door Trim Panel Retainers
G.M. # 10143422
Ford # N805612-S100, N805612-S
AMC # 893202-599, 8934-202-599

50 Pcs.



Chrysler Door Panel Retainers

2063PK 17/64" (7mm) Hole Size 15mm Stem Length
13mm Top Head Diameter
White Nylon Door Trim Panel Retainers
Chrysler # 6504014, 6503896
Dodge # 6502907, 6542907

50 Pcs.



2108PK 3/8" (9.5mm) Hole Size 14mm Stem Length
15mm Top Head Diameter
White Nylon Door Trim Panel Retainers
Ford # W706812S300 Chrysler # 6505292AA

25 Pcs.



10464PK 3/8" (9.5mm) Hole Size 14mm Stem Length
15mm Top Head Diameter
Yellow & White Nylon Door Trim Panel Retainers
Chrysler # 6505918-AA

25 Pcs.



Honda Door Panel Retainers

9444PK 5/16" (8mm) Hole Size 15mm Stem Length
13mm Top Head Diameter
White Nylon Door Trim Panel Retainers
Honda # 91560-SM4-003

25 Pcs.

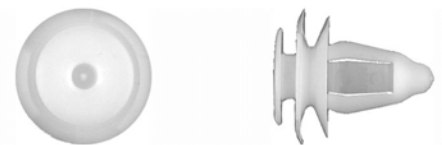

10573PK 21/64" (8.5mm) Hole Size 13mm Stem Length
13mm Top Head Diameter
Blue Nylon Door Trim Panel Retainers
Honda # 91560-S9A-A01

25 Pcs.



Mazda Door Panel Retainers

10575PK 5/16" (8mm) Hole Size 10mm Stem Length
15mm Top Head Diameter
Black Nylon Door Trim Panel Retainers
Mazda # GA2A-68-AB1A

10 Pcs.



10405PK 23/64" (9mm) Hole Size 14mm Stem Length
14mm Top Head Diameter
White Nylon Door Trim Panel Retainers
Mazda # 9927-40-822

25 Pcs.



Door Fasteners

Mazda Door Panel Retainers

10749PK 7/16" (11mm) Hole Size 14mm Top Head Dia.
14mm Stem Length
White Nylon With Sealer Door Trim Panel Retainers
Mazda # G18K-51-SJ3

10 Pcs.



Nissan Door Panel Retainers

10576PK 5/16" (8mm) Hole Size 14mm Stem Length
12.8mm Top Head Diameter
Orange Nylon With Sealer Door Trim Panel Retainers
Nissan # 80999-VE000

25 Pcs.



9539PK 5/16" (8mm) Hole Size 17.5mm Stem Length
13mm Top Head Diameter
Natural Nylon Door Trim Panel Retainers
Nissan # 01553-S3500

50 Pcs.



Toyota Door Panel Retainers

10687PK 21/64" (8.5mm) Hole Size 14mm Stem Length
13mm Top Head Diameter
Turquoise Nylon Door Trim Panel Retainers
Toyota # 90467-10188

25 Pcs.



2145PK 23/64" (9mm) Hole Size 11mm Stem Length
13mm Top Head Diameter
Natural Nylon Door Trim & Garnish Retainers
Toyota # 67771-30070

25 Pcs.



10748PK 23/64" (9mm) Hole Size 13mm Stem Length
13mm Top Head Diameter
White Nylon Door Panel & Rocker Moulding Clips
Toyota # 67771-12080

15 Pcs.



9081PK 11/32" (9mm) Hole Size 14mm Stem Length
3mm Top Head Diameter
Natural Nylon Door Trim Panel Retainers
Isuzu # 8942264920 Mazda # 9927-40-825
Toyota # 67771-01010, 67771-12010

25 Pcs.



Door Hinge Pin Bushings

9233PK 21/64" I.D. 9/16" O.D. 1/64" Thick
Stainless Steel
Door Hinge Pin Retainers (Use with # 9164PK)
G.M. # 15562610

50 Pcs.





1267PK .345" Inside Diameter .419" Outside Diameter
.295" Height
Door Hinge Pin Bushings
G.M. # 9721917 Ford # D1AZ-6522841A

25 Pcs.





Door Fasteners

Door Hinge Pin Bushings

2115PK	.385" Inside Diameter .530" Outside Diameter .365 Height Door Hinge Pin Bushings G.M. # 15562609, 6632192, 5964972	25 Pcs.	
1268PK	.345" Inside Diameter .489" Outside Diameter .362" Height Door Hinge Pin Bushings G.M. # 20429500	25 Pcs.	
2114PK	.345" Inside Diameter .495" Outside Diameter .365" Height Door Hinge Pin Bushings G.M. # 12338074, 15964971, 15691493, 16632193	25 Pcs.	

Door Hinge Pins

1288PK	11/32" Pin Diameter 4 1/16" Length 9/16" Head O.D. Bright Zinc Steel Door Hinge Pins G.M. # 6271989, 20046147	10 Pcs.	
9825PK	11/32" Pin Diameter 4 1/8" Length 1/2" Head O.D. Yellow Zinc Steel Door Hinge Pins G.M. # 15653790	2 Pcs.	 (Yellow Zinc Finish)
9164PK	11/32" Pin Diameter 5 1/4" Length 19/32" Head O.D. Stainless Steel Door Hinge Pins G.M. # 15591860, 15691595, 15691595X G.M. # 15967691, 15685040	5 Pcs.	 (Stainless Steel)

Door Hinge Pin & Bushing Kits

9818	G.M. Trucks C-K 1988 - On Kit Will Repair One Hinge Stainless Steel Door Hinge Pin & Bushing Kit	1 Kit	 (Stainless Steel Pin)
-------------	--	--------------	---

Door Fasteners

Door Hinge Pin & Bushing Kits



10060

GMC Sierra & Chev. Silverado & Other S.U.V.'S Hinges
Kit Will Repair One Hinge
Yellow Zinc Finish Door Hinge Pin & Bushing Kit

1 Kit

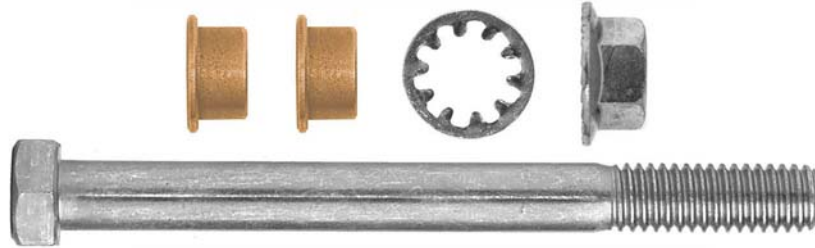

9948

Dodge Trucks 1994 - 2003 Dodge Ram
Kit Will Repair One Hinge
Bright Zinc Finish Door Hinge Pin & Bushing Kit

1 Kit

Bumper Hardware

Toyota Bumper Hardware

1584PK

16mm Width 27mm Length
Bright Zinc Finish
Bumper Strip Retainers
Toyota # 90468-04030

25 Pcs.



Headlight & Grille Fasteners

Headlight Screw & Nuts

972PK

1/4-28 x 2" Screw Size
White Nylon Nut
Headlight Adjusting Screw & Nut Assembly
G.M. # 343543, 343555, 354076, 362379, 3921446
15705372, 343541, 343542

10 Pcs.



1003PK

12-28 x 2" Screw Size
Blue Nylon Nut
Headlight Adjusting Screw & Nut Assembly
G.M. # 556196, 557057

25 Pcs.

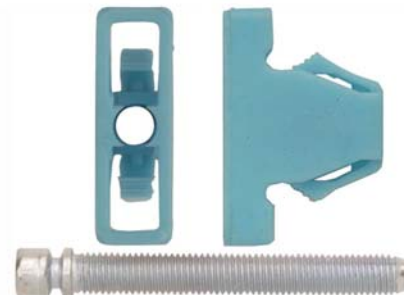

Headlight & Grille Fasteners

Headlight Retainers

1864PK Zinc Finish
Headlight Component
Retaining Clips
Ford # E9DB-13N020AA, E9DZ-13N129A,
F2AB-13N020-AA

25 Pcs.

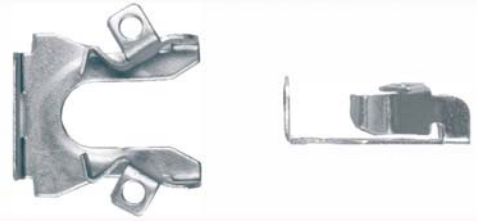

G.M. Grille Fasteners

9199PK #8 Screw Size
Black Finish
Radiator Grille Nuts
G.M. # 15686142

25 Pcs.



Windshield Fasteners

Reveal Moulding

9548PK 20mm Width 24mm Length
Windshield &
Rear Window Reveal Moulding Clips
G.M. # 20603072, 9606232, 9662950

100 Pcs.



9550PK 18mm Width 22mm Length
Windshield &
Rear Window Reveal Moulding Clips
Ford # C5ZZ-6543413-B, D1AZ-6542113-B,
D1AB-6542413-AB

100 Pcs.



1172PK 9/16" Width 61/64" Length
White Nylon
Quarter Belt Reveal Moulding Clips
G.M. # 20175051, 15633873

50 Pcs.



Moulding Clips

G.M. Moulding Clips

10823PK 17/64" (7mm) Hole Size 13mm Stem Length
13mm Width 30mm Length
White Nylon With Sealer Roof Rail Moulding Clips
G.M. #11569918

15 Pcs.



9969PK 5/16" (8mm) Hole Size 11/16" Stem Length
15/32" x 1 5/16" Head Size
Black Nylon Rocker Panel Moulding Clips
G.M. # 10437565

10 Pcs.



Moulding Clips

G.M. Moulding Clips

9967PK	5/16" (8mm) Hole Size 11/16" Stem Length 11/16" x 1 5/16" Head Size Black Nylon Rocker Panel Moulding Clips G.M. # 10352799	15 Pcs.		
10489PK	5/16" (8mm) Hole Size 11/16" Stem Length 11/16" x 1 5/16" Head Size Gray Nylon Rocker Panel Moulding Clips G.M. # 10352797	15 Pcs.		
10488PK	5/16" (8mm) Hole Size 11/16" Stem Length 11/16" x 1 5/16" Head Size Tan Nylon Rocker Panel Moulding Clips G.M. # 10431523	15 Pcs.		
10480PK	23/64" (9mm) Hole Size 11mm Stem Length 12mm x 20mm Top Head Size White Nylon Body Side Moulding Clips G.M. # 15127746	15 Pcs.		
10357PK	23/64" (9mm) Hole Size 14mm Stem Length 12mm x 20mm Top Head Size White Nylon Rocker Panel Moulding Clips G.M. # 10323057	15 Pcs.		
10485PK	23/64" (9mm) Hole Size 14mm Stem Length 14mm x 20mm Top Head Size Yellow Nylon With Sealer Rocker Panel Moulding Clips G.M. # 5480852	10 Pcs.		
10481PK	23/64" (9mm) Hole Size 15mm Stem Length 12mm x 20mm Top Head Size Gray Nylon With Sealer Windshield Pillar Mldg. Clips G.M. # 15288146, 15893516	15 Pcs.		

Moulding Clips

G.M. Moulding Clips

10680PK 3/8" (9.5mm) Hole Size 9/16" Stem Length
9/16" x 13/16" Top Head Size
White Nylon Rocker & Grille Moulding Clips
G.M. # 25724529

15 Pcs.



10827PK 25/64" (10mm) Hole Size 15mm Stem Length
12mm x 20mm Top Head
White Nylon Rocker Moulding Clips
G.M. # 11562563

15 Pcs.

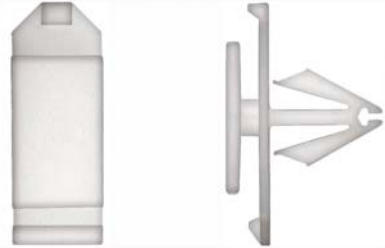

10482PK 25/64" (10mm) Hole Size 15mm Stem Length
16mm x 38mm Top Head Size
Green Nylon Body Side Moulding Clips
G.M. # 15116576, 15282120

15 Pcs.

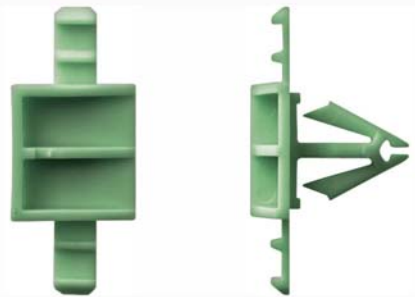

9991PK 7/16" (11mm) Hole Size 9/16" Stem Length
15/32" x 25/32" Top Head Size
Natural Nylon With Sealer Rear Wheel Opening
Mldg. Clips
G.M. # 10297368

10 Pcs.



9990PK 7/16" (11mm) Hole Size 9/16" Stem Length
19/32" x 25/32" Top Head Size
Yellow Nylon With Sealer Rear Wheel Opening
Mldg. Clips
G.M. # 10297371

15 Pcs.



9914PK 7/16" (11mm) Hole Size 9/16" Stem Length
15/32" x 13/16" Top Head Size
Green Nylon Rocker Panel Moulding Clips
G.M. # 10423553

15 Pcs.



9992PK 7/16" (11mm) Hole Size 9/16" Stem Length
9/16" x 13/16" Top Head Size
Black Nylon Front Fender W/Opening Mldg. Clips
G.M. # 10242298

25 Pcs.



9915PK 7/16" (11mm) Hole Size 9/16" Stem Length
9/16" x 3/16" Top Head Size
White Nylon Rocker Panel Moulding Clips
G.M. # 10443956

15 Pcs.



Moulding Clips

G.M. Moulding Clips

10129PK	7/16" (11mm) Hole Size 9/16" Stem Length 9/16" x 13/16" Top Head Natural Nylon With Sealer Rocker Panel Moulding Clips G.M. # 11518357	15 Pcs.	
10429PK	7/16" (11mm) Hole Size 9/16" Stem Length 9/16" x 1 1/8" Top Head Size Gray Nylon Rocker Panel Moulding Clips G.M. # 15221959	15 Pcs.	
10056PK	7/16" (11mm) Hole Size 19/32" Stem Length 3/4" x 1" Top Head Size White Nylon Rocker Panel Moulding Clips G.M. # 22603384	15 Pcs.	
10058PK	7/16" (11mm) Hole Size 1 1/4" Stem Length 11/16" x 1 1/2" Top Head Size Gray Nylon Rocker Panel Moulding Clips G.M. # 10431761, 10411395	15 Pcs.	
10059PK	7/16" (11mm) Hole Size 17/32" Stem Length 7/8" Width 2" Length Gray Nylon Rocker Panel Moulding Clips G.M. # 25722671	10 Pcs.	
10128PK	7/16" (11mm) Hole Size 21/32" Stem Length 7/8" Width 2" Length Gray Nylon Rocker Moulding Clips G.M. # 25648693	10 Pcs.	

Moulding Clips

G.M. Moulding Clips

10651PK 21/32" (17mm) Hole Size 12mm Stem Length
20mm x 30mm Top Head Size
Black Nylon With Sealer Rocker Panel Moulding
Clips
G.M. # 11561491, 15872008

10 Pcs.

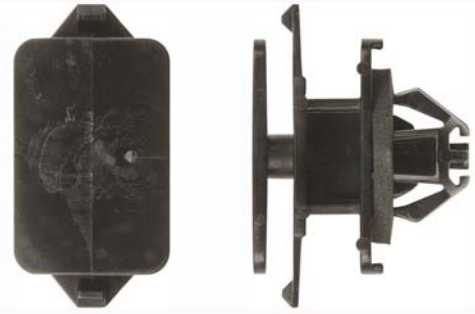

Lexus Moulding Clips

10397PK 15/16" (8mm) Hole Size 20mm Stem Length
18mm Head Diameter
Yellow Nylon With Sealer Fender Moulding Clips
Lexus # 75394-60060

10 Pcs.

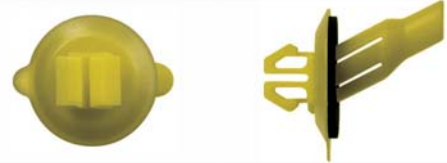

10396PK 15/16" (8mm) Hole Size 20mm Stem Length
18mm Head Diameter
Gray Nylon With Sealer Fender Moulding Clips
Lexus # 75492-60030

10 Pcs.



10493PK 11/32" (9mm) Hole Size 9mm Stem Length
18mm Head Diameter
Pink Nylon With Sealer Moulding Clips
Lexus # 75395-33030

15 Pcs.



10491PK 15/32" (12mm) Hole Size 10mm Stem Length
18mm Head Diameter
Gray Nylon Rocker Panel Moulding Clips
Lexus # 75392-60030

15 Pcs.



Saturn Moulding Clips

10826PK 23/64" (9mm) Hole Size 15mm Stem Length
12mm x 20mm Top Head Size
Black Nylon Rocker Moulding Clips
Saturn

15 Pcs.



Toyota Moulding Clips

10392PK 11/32" (9mm) Hole Size 17mm Stem Length
18mm Head Diameter
White Nylon With Sealer Rocker Panel Moulding
Clips
Toyota # 90467-11063 Suzuki # 77553-65D00

15 Pcs.













10112PK 11/32" (9mm) Hole Size 17mm Stem Length
17mm Head Diameter
Yellow Nylon Fender & Wheel Flare Moulding Clips
Toyota # 90467-11100

10 Pcs.



Moulding Clips

Toyota Moulding Clips

9946PK	11/32" (9mm) Hole Size 13mm Stem Length 17mm Head Diameter Red Nylon Fender Moulding Clips Toyota # 90904-67037	10 Pcs.		
10113PK	11/32" (9mm) Hole Size 17mm Stem Length 17mm Head Diameter Blue Nylon Fender & Wheel Flare Moulding Clips Toyota # 90904-67036	10 Pcs.		
10492PK	11/32" (9mm) Hole Size 17mm Stem Length 17mm Head Diameter Orange Nylon With Sealer Wheel Flare Moulding Clips Toyota # 75397-35010	10 Pcs.		
10490PK	25/64" (10mm) Hole Size 11mm Stem Length 17mm Head Diameter Blue Nylon With Sealer Rocker Moulding Clips Toyota # 75495-35010	10 Pcs.		
10394PK	9mm x 12mm Hole Size 20mm Stem Length 20mm Head Diameter White Nylon Garnish Moulding Clips Toyota # 75498-42010	10 Pcs.		

Universal Moulding Clips

308PK	3/8" Hole Size Front & Rear Door Universal Moulding Clips G.M. # 4759145, 4761842, 4779348	50 Pcs.		
347PK	10-24 x 3/4" Screw Size 11/32" x 23/32" Plate Size Universal Moulding Clips Chrysler # 1624705	50 Pcs.		
9879PK	10-24 x 3/4" Bolt Size 1/2" x 1 1/16" Plate Size Universal Moulding Clips G.M. # 568792, 574355, 1165051 Ford # 358560 Chrysler # 1560058, 6010029	25 Pcs.		

Moulding Clips

Universal Moulding Clips

345PK 10-24 x 3/4" Bolt Size
1/2" x 1 25/64" Plate Size
Universal Moulding Clips
G.M. # 3722635 Chrysler # 6000705, 6013029

50 Pcs.



9711PK 10-24 x 3/4" Bolt Size
11/16" x 2 17/32" Plate Size
Commerical Zinc Finish Universal Moulding Clips
G.M. # 4676189

15 Pcs.



Hole Plugs

Hole Plugs Flush Type Black

1302PK 3/8" Hole Size 3/4" Head Diameter
Flush Type
Black Plastic Hole Plugs

100 Pcs.



1091PK 1/2" Hole Size 7/8" Head Diameter
Flush Type
Black Plastic Hole Plugs

100 Pcs.

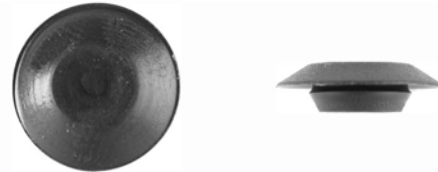

1379PK 3/4" Hole Size 1" Head Diameter
Flush Type
Black Plastic Hole Plugs

100 Pcs.

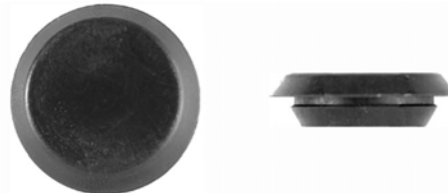

Hole Plugs Depressed Center Black



















9386PK 1/2" Hole Size 7/8" Head Diameter
Depressed Center
Black Plastic Hole Plugs

100 Pcs.





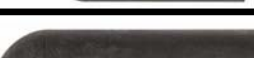

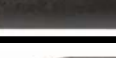
Vacuum Caps & Connectors

Vacuum Caps

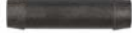









10639PK	1/8" O.D. Tube Size 9/16" Inside Length Black Rubber Vacuum Caps Ford # 380615-S, 38766-S	25 Pcs.		
10640PK	3/16" O.D. Tube Size 9/16" Inside Length Black Rubber Vacuum Caps Ford # 380614-S	25 Pcs.		
10641PK	3/16" O.D. Tube Size 1 1/4" Inside Length Black Rubber Vacuum Caps	25 Pcs.		
10642PK	1/4" O.D. Tube Size 9/16" Inside Length Black Rubber Vacuum Caps	25 Pcs.		
10643PK	1/4" O.D. Tube Size 1 1/4" Inside Length Black Rubber Vacuum Caps	25 Pcs.		
10644PK	5/16" O.D. Tube Size 9/16" Inside Length Black Rubber Vacuum Caps	25 Pcs.		
10645PK	5/16" O.D. Tube Size 1 1/4" Inside Length Black Rubber Vacuum Caps Ford # 389129-S	25 Pcs.		
10646PK	3/8" O.D. Tube Size 31/32" Inside Length Black Rubber Vacuum Caps Ford # 385353-S	25 Pcs.		
10647PK	3/8" O.D. Tube Size 1 1/2" Inside Length Black Rubber Vacuum Caps	25 Pcs.		
10648PK	1/2" O.D. Tube Size 11/16" Inside Length Black Rubber Vacuum Caps Ford # 388916-S	10 Pcs.		

Vacuum Connectors

11295PK	1/8" x 1/8" Hose I.D. Barbed Type Black Nylon Hose Straight Connectors	10 Pcs.	
11296PK	3/16" x 3/16" Hose I.D. Barbed Type Black Nylon Hose Straight Connectors	10 Pcs.	
11297PK	1/4" x 1/4" Hose I.D. Barbed Type Black Nylon Hose Straight Connectors	10 Pcs.	
11298PK	5/16" x 5/16" Hose I.D. Barbed Type Black Nylon Hose Straight Connectors	10 Pcs.	
11299PK	3/8" x 3/8" Hose I.D. Barbed Type Black Nylon Hose Straight Connectors	10 Pcs.	









Vacuum Caps & Connectors

Vacuum Connectors

11294PK	1/4" x 3/16" Hose I.D. Barbed Type Black Nylon Hose Reducer Connectors	10 Pcs.	
11293PK	3/8" x 1/4" Hose I.D. Barbed Type Black Nylon Hose Reducer Connectors	10 Pcs.	
11288PK	1/8" x 1/8" x 1/8" Hose I.D. Barbed Type Black Nylon Hose Tee Connectors	10 Pcs.	
11289PK	5/32" x 5/32" x 5/32" Hose I.D. Barbed Type Black Nylon Hose Tee Connectors	10 Pcs.	
11290PK	3/16" x 3/16" x 3/16" Hose I.D. Barbed Type Black Nylon Hose Tee Connectors	10 Pcs.	
11291PK	1/4" x 1/4" x 1/4" Hose I.D. Barbed Type Black Nylon Hose Tee Connectors	10 Pcs.	
11292PK	3/8" x 3/8" x 3/8" Hose I.D. Barbed Type Black Nylon Hose Tee Connectors	10 Pcs.	
11300PK	1/8" x 1/8" Hose I.D. Barbed Type Natural Nylon Hose Straight Connectors G.M. # 14047034 Ford # 383000 Chrysler # 4095145	10 Pcs.	
11302PK	3/16" x 3/16" Hose I.D. Barbed Type Natural Nylon Hose Straight Connectors G.M. # 560625, 22508051, Ford # 383003, 389138 Chrysler # 4104998	10 Pcs.	
11304PK	1/4" x 1/4" Hose I.D. Barbed Type Natural Nylon Hose Straight Connectors G.M. # 1614858, 14004876, 10017487 Ford # 383005	10 Pcs.	

Vacuum Caps & Connectors

Vacuum Connectors

11301PK	1/8" x 3/16" Hose I.D. Barbed Type Black Nylon Hose Reducer Connectors G.M. # 14017701 Ford # 383001 Chrysler # 3441743, 4241296	10 Pcs.	
11303PK	3/16" x 1/4" Hose I.D. Barbed Type Black Nylon Hose Reducer Connectors G.M. # 1621253, 472812 Ford # 800843 AMC # 3239826	10 Pcs.	
11306PK	1/8" x 1/8" x 1/8" Hose I.D. Barbed Type Natural Nylon Hose Tee Connectors G.M. # 14017705 Ford # 3895904 Chrysler # 3751212	10 Pcs.	
11308PK	3/16" x 3/16" x 3/16" Hose I.D. Barbed Type Natural Nylon Hose Tee Connectors G.M. # 357020, 272766, 22508050 Ford # 373846-S Chrysler # 3671410 AMC # 3673945	10 Pcs.	
11310PK	1/4" x 1/4" x 3/16" Hose I.D. Barbed Type Natural Nylon Hose Reducer Tee Connectors G.M. # 3963228	10 Pcs.	
11311PK	5/16" x 5/16" x 5/16" Hose I.D. Barbed Type Black Nylon Hose Tee Connectors	10 Pcs.	
11307PK	3/16" x 3/16" x 1/8" Hose I.D. Barbed Type Black Nylon Hose Reducer Tee Connectors G.M. # 14031114	10 Pcs.	
11309PK	1/4" x 3/16" x 3/16" Hose I.D. Barbed Type Natural Nylon Hose Reducer Tee Connectors G.M. # 1617333, 10003294, 6466355 Ford # 388034, 12920 Chrysler # 4167810	10 Pcs.	

Vacuum Caps & Connectors

Vacuum Connectors

11305PK 3/8" x 3/8" x 1/4" Hose I.D. **10 Pcs.**
 Barbed Type
 Black Nylon Hose Reducer Tee Connectors
 G.M. # 472815 Ford # D9AE-9E645AA



Rivets

Pop Rivets Nylon

9053PK 13/64" (5.15mm) Hole Size 1/16" - 11/64" Grip Range **25 Pcs.**
 15/32" Flange Diameter
 Black Nylon Blind Rivets
 G.M. # 20423647 Mazda # B455-56-741



5769PK 13/64" (5.15mm) Hole Size 15/32" Flange Diameter **25 Pcs.**
 1/8" - 15/64" Grip Range
 Black Nylon Blind Rivets
 G.M. # 20432975 Ford # 8048635
 Chrysler # 6500859, 6500899 AMC # 34202855
 Volkswagen # 175-853-577, 175-853-57701C, 175-852-577



1195PK 13/64" (5.15mm) Hole Size 15/32" Flange Diameter **25 Pcs.**
 15/64" - 25/64" Grip Range
 Black Nylon Blind Rivets
 Chrysler # 6500898



1390PK 1/4" (6.35mm) Hole Size 1/2" Flange Diameter **25 Pcs.**
 5/32" - 13/32" Grip Range
 Black Nylon Blind Rivets
 G.M. # 20452072 Ford # N803862-S
 Chrysler # 6501559, 6506007AA



9854PK 15/64" (5.95mm) Hole Size 5/8" Flange Diameter **25 Pcs.**
 5/32" - 5/16" Grip Range
 Black Nylon Blind Rivets
 G.M. # 10036503



5770PK 1/4" (6.35mm) Hole Size 21/32" Flange Diameter **25 Pcs.**
 5/32" - 13/32" Grip Range
 Black Nylon Blind Rivets
 G.M. # 14063981, 15506827, 15506921
 Ford # KA01500Z1, N803043-S
 Chrysler # 6500911 AMC # 8934-201-631



9128PK 1/4" (6.35mm) Hole Size 21/32" Flange Diameter **25 Pcs.**
 5/16" - 15/32" Grip Range
 Black Nylon Blind Rivets
 G.M. # 21110122 Ford # N804675S
 Chrysler # 4370138, 6503860



9054PK 17/64" (6.74mm) Hole Size 1/2" Flange Diameter **25 Pcs.**
 3/32" - 3/16" Grip Range
 Black Nylon Blind Rivets
 G.M. # 20421672, 15595172, 15955172



5775PK 17/64" (6.74mm) Hole Size 23/32" Flange Diameter **25 Pcs.**
 3/32" - 3/16" Grip Range
 Black Nylon Blind Rivets
 G.M. # 20433026, 14070914 Chrysler # 4370132
 Volkswagen # 175-553-577A, 175-853-577A



Rivets

Pop Rivets Automotive

9118PK	1/8" (3.1mm) Hole Size 3/8" Flange Diameter 1/16" - 1/8" Grip Range Black Alum. Rivet Steel Mandrel Windshield Side Rail Rivets Replaces Ford # N805759-S100	50 Pcs.	
4009PK	1/4" (6.3mm) Hole Size 1/2" Flange Diameter 3/32" - 1/8" Grip Range Aluminum Rivet Steel Mandrel Black Outside Door Handle Rivets Ford # 388047-S102	25 Pcs.	
1799PK	1/8" (3.1mm) Hole Size 3/8" Flange Diameter 1/8" - 3/16" Grip Range Black Aluminum Rivet Steel Mandrel Pop Rivets	50 Pcs.	
9851PK	1/4" (6.3mm) Hole Size 1/2" Flange Diameter 11/16" - 3/4" Grip Range Aluminum Rivet Steel Mandrel Window Regulator Peel Rivets G.M. # 12338153, 20184399 Ford # 389268-S100	25 Pcs.	
10960PK	1/4" (6.3mm) Hole Size 3/4" Flange Diameter 3/32" - 9/64" Grip Range Black Alum/Steel Mandrel Door Handle & Door Lock Actuator Rivets G.M. # 15672713, 9441592 Ford # N804193-S100	25 Pcs.	
9277PK	5/32" (3.9mm) Hole Size 15/32" Flange Diameter 1/4" - 3/8" Grip Range Black Alum. Rivet Steel Mandrel Wheel Opening Mldg. Pop Rivets V.W. # N900-845-01	25 Pcs.	
9278PK	3/16" (4.7mm) Hole Size 3/8" Flange Diameter 3/64" - 11/32" Grip Range Black Aluminum Moulding Attachment Split Type Rivets G.M. # 10125439	25 Pcs.	
1609PK	3/16" Hole Size 7/16" Flange Diameter 5/64" - 15/64" Grip Range Black Aluminum Wheel House Moulding Split Rivets G.M. # 25618730 Ford # N805592-S100	25 Pcs.	
4005PK	3/16" (4.7mm) Hole Size 9/16" Flange Diameter 3/8" - 1/2" Grip Range Black Aluminum Grille & Fascia Pop Rivets Ford # 388664-S100	25 Pcs.	
4007PK	1/4" (6.3mm) Hole Size 1/2" Flange Diameter 1/32" - 9/64" Grip Range Aluminum Rivet Steel Mandrel Window Regulator Peel Rivets G.M. # 9436175 Ford # 385189-S100 Chrysler # 6031115	25 Pcs.	
9902PK	1/4" (6.3mm) Hole Size 1/2" Flange Diameter 9/64" - 3/16" Grip Range Aluminum Rivet Steel Mandrel Window Regulator Peel Rivets G.M. # 9437486 Chrysler # 6032926	25 Pcs.	
4002PK	1/4" (6.3mm) Hole Size 1/8" - 1/4" Grip Range 3/4" Flange Diameter Black Rivet All Steel Bumper Assembly Rivets Ford # 388442-S100	25 Pcs.	

Rivets

Pop Rivets Automotive

4008PK 1/4" (6.3mm) Hole Size 33/64" - 19/32" Grip Range **25 Pcs.**
 1/2" Flange Diameter
 Aluminum Rivet Steel Mandrel Glass Stop Peel Rivets
 G.M. # 9437938 Ford # 385323-S100
 Chrysler # 6031091



1951PK 1/4" (6.3mm) Hole Size 11/16" Flange Diameter **15 Pcs.**
 3/16" - 3/8" Grip Range
 Black Aluminum Bumper Cover Split Rivets
 Ford #N806860-S100, N806830-S100
 Chrysler # 6035201



Pop Rivets Aluminum

10587PK 1/8" Hole Size 1/32" - 1/16" Grip Range **100 Pcs.**
 1/4" Flange Size
 All Aluminum Pop Rivets
 Industrial # 41



10589PK 1/8" Hole Size 1/8" - 3/16" Grip Range **100 Pcs.**
 1/4" Flange Size
 All Aluminum Pop Rivets
 Industrial # 43



9243PK 1/8" Hole Size 1/4" Flange Diameter **100 Pcs.**
 3/16" - 1/4" Grip Range
 Black Finish All Aluminum Pop Rivets
 Industrial # 44



1889PK 1/8" Hole Size 3/16" - 1/4" Grip Range **100 Pcs.**
 1/4" Flange Size
 All Aluminum Pop Rivets
 Industrial # 44



9596PK 1/8" (3.1mm) Hole Size 3/8" Large Flange Size **100 Pcs.**
 3/16" - 1/4" Grip Range
 All Aluminum Pop Rivets
 Industrial # 44L



1890PK 1/8" Hole Size 5/16" - 3/8" Grip Range **100 Pcs.**
 1/4" Flange Size
 All Aluminum Pop Rivets
 Industrial # 46



1900PK 3/16" Hole Size 1/8" - 1/4" Grip Range **100 Pcs.**
 3/8" Flange Size
 All Aluminum Pop Rivets
 Industrial # 64



1901PK 3/16" Hole Size 1/4" - 3/8" Grip Range **100 Pcs.**
 3/8" Flange Size
 All Aluminum Pop Rivets
 Industrial # 66



1904PK 3/16" Hole Size 1/4" - 3/8" Grip Range **100 Pcs.**
 5/8" Large Flange Size
 All Aluminum Pop Rivets
 Industrial # 66L



10966PK 5/32" Hole Size 7/16" Flange Diameter **25 Pcs.**
 3/64" - 1/4" Grip Range
 All Aluminum Black Finish Split Type Pop Rivets
 Chrysler # 6036148-AA



Pop Rivets Steel

11083PK 1/8" Hole Size 3/16" - 1/4" Grip Range **100 Pcs.**
 1/4" Flange Diameter
 All Steel Pop Rivets
 Industrial # 44



Rivets

Pop Rivets Steel

11085PK 1/8" Hole Size Grip Range: 5/16" - 3/8"
Flange Diameter: 1/4"
All Steel Pop Rivets
Industrial # 46

100 Pcs.



Shims

Shims Body Steel

6016PK 1/8" Thick 3/8" Slot
1 1/4" x 1 1/8"
Bright Zinc Finish Steel Body Shims

100 Pcs.

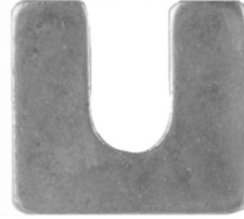

11042PK 1/8" Thickness 5/8" Slot Size
1 3/8" x 1 1/4"
Bright Zinc Finish Steel Shims

50 Pcs.



9974PK 1/16" Thick 1/2" Slot
1 1/8" x 1 1/8"
Bright Zinc Finish Steel Body Shims

50 Pcs.



9975PK 1/8" Thick 1/2" Slot
1 1/8" x 1 1/8"
Bright Zinc Finish Steel Body Shims

50 Pcs.



10985PK 3/16" Thick 5/8" Slot
1 3/8" x 1 1/4"
Bright Zinc Finish Steel Body Shims

25 Pcs.



Electrical Products

Wire Loom Routing Clips

1239PK 1/2" Inside Diameter
11/16" Outside Diameter
Black Nylon Wire Loom Routing Clips
G.M. # 8911472 **25 Pcs.**



Cable Ties Nylon

9279PK 140mm Long 30mm Max. Bundle Diameter
Universal Use
Black Nylon Releasable Cable Straps
Honda # 90672-SA0-0030 Mazda #
9928-91-053353 **25 Pcs.**



9325PK 8" Length Up To 1 3/4" Bundle Diameter
50 lbs. T/Strength 1/4" Hole Dia.
UV Black Nylon Push Mount Cable Ties **25 Pcs.**



Assortments

Assortment Import Door Trim Panel

8109 Honda, Hyundai, Nissan, Mazda & Toyota
6 3/4" x 11" Plastic Tray
170 Total Pcs. Contains 12 Different Sizes
Import Door Trim Panel Assortment **Sold Each**



Assortment Weatherstrip Retainer

8150 G.M., Ford, Chrysler, Honda & Toyota
6 3/4" x 11" Plastic Tray
300 Total Pcs. Contains 12 Different Sizes
Weatherstrip Retainer Assortment **Sold Each**



Assortments

Assortment Moulding Clip

8173 Toyota & Lexus 8mm to 10mm Hole Size
6 3/4" x 11" Plastic Tray
154 Total Pcs. Contains 11 Different Sizes
Moulding Clip Assortment

**Sold
Each**



Assortment Toyota Retainer

8174 Various Models Of Toyota Cars
6 3/4" x 11" Plastic Tray
146 Total Pcs. Contains 12 Different Sizes
Retainer Assortment

**Sold
Each**

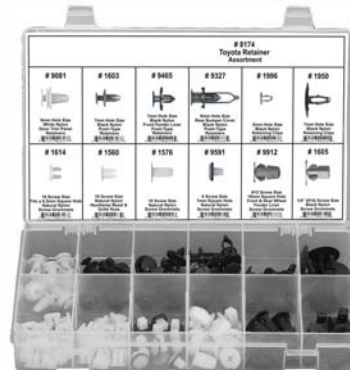

Assortment Nissan Retainer

8175 6 3/4" x 11" Plastic Tray Nissan Cars
All Nylon
Contains 12 Different Sizes 123 Total Pcs.
Retainer Assortment

**Sold
Each**



Assortment Honda Retainer

8177 Honda Cars All Nylon
6 3/4" x 11" Plastic Tray
121 Total Pcs. Contains 12 Different Sizes
Retainer Assortment

**Sold
Each**



Assortments

Assortment Rod End Clip

8184 3 5/8" x 7 1/8" Plastic Tray Covers G.M., Ford, Chrysler
All Nylon Retainers
Contains 6 Different Sizes 33 Total Pcs.
Rod End Clip Assortment

Sold Each



Assortment Cotter Pin

8185 3 5/8" x 7 1/8" Plastic Tray Hammerlock Type
Bright Zinc Finish
Contains 6 Different Sizes 150 Total Pcs.
Cotter Pin Assortment

Sold Each



Assortment Shield Retainer

8601 Universal Use Covers 2.5mm to 10mm Hole Sizes
24 Hole Gray Plastic Tray
336 Total Pcs. Contains 24 Different Sizes
Shield Retainer Assortment

Sold Each



Assortments

Assortment Body Bolt & Nut

8603 "U" Nuts, Hex Nuts & Body Bolts
24 Hole Gray Plastic Tray
203 Total Pcs. Contains 22 Different Sizes
Body Bolt & Nut Assortment

**Sold
Each**



Assortment G.M. Rocker Panel Moulding

8620 Covers G.M. Cars & Trucks
24 Hole Gray Plastic Tray
220 Total Pcs. Contains 24 Different Sizes
G.M. Rocker Panel Moulding Assort

**Sold
Each**



Assortment Ergo Tufloks Retainer

8637 Universal Use Covers 6.5mm to 10mm Hole Sizes
12 1/4" x 18 1/4" Gray Plastic Tray
280 Total Pcs. Contains 11 Different Sizes
Ergo Tufloks Retainer Assortment

**Sold
Each**



Assortments

Assortment Body Shop Fastener



FREE

32 Compartment Tip Out Storage Cabinet

Strong & Durable for Bench Top and Wall Mounting

19" W x 26-3/4" H x 4" D
\$65.00 Value #Cabinet

Free Cabinet With Purchase of
#8051 Fastener Assortment
\$149.00

Includes One Box Each (1480 Pieces) of These 30 Most Popular Part Numbers:

6402PK	#8 x 1" w/ #6 Head Phillips Oval Head Tapping Screws
688PK	M8-1.25 x 30mm Hex Head Sems Body Bolts
9160PK	M4.2-1.41 x 20mm Phillips Washer Head Tapping Screws
11134PK	M6-1.0 x 25mm Hex Head Sems Body Bolts
5686PK	M6-1.0 x 25mm Hex Head Sems Body Bolts
11040PK	#8 Screw Size "U" Nuts
10815PK	M8-1.25 Extruded "U" Nuts
10812PK	M6-1.0 Extruded "U" Nuts
5750PK	#8 Screw Size Spring Type "U" Nuts
5429PK	GM, Ford & Chrysler Panel Retainers
5440PK	GM Hood Insulation Retainers
1024PK	GM & Chrysler Trim Panel Retainers
5710PK	GM Radiator Panel Retainers
5675PK	GM Push-Type Retainers
5676PK	GM Push-Type Retainers
1575PK	Ford Trim Panel Retainers
5625PK*	GM, Ford & Chrysler Panel Retainers
6016PK	Shims w/ 3/8" Slot
9974PK	Shims w/ 1/2" Slot
1684PK	1/8" Stud Size Push-On Retainers
1650PK	License Plate Thumb Screws
1267PK	GM & Ford Door Hinge Bushings
D-123PK	Honda Push-Type Retainers
6010PK	#8 x 1/2" Phillips Washer Head Teks Tapping Screws
9132PK*	GM Bumper Fascia Retainers
5648PK	GM & Ford Fascia Retainers
4007PK	GM, Ford & Chrysler Window Regulator Rivets
1620PK*	#14 x 3/4" Slotted Hex Washer Head License Plate Screws
1228PK	GM License Plate Nylon Nuts
1939PK	S#14 x 5/8" Slotted Hex Washer Head License Plate Screws

* Two Boxes Each

Service Equipment

Storage Cabinet

80321 26 3/4" High 19" Wide x 4" Deep
32 Hole Tray
22 Ga. Steel Frame Black Baked Enamel
Storage Cabinet

**Sold
Each**



O.E.M. Interchange

O.E.M. #	Make	Carolina #	O.E.M. #	Make	Carolina #
01281-00023	Nissan	1576	11500662	G.M.	5558
01553-00172	Nissan	1466	11500754	G.M.	5688
01553-00755	Nissan	9114	11500970	G.M.	1013
01553-03101	Nissan	2153	11500971	G.M.	5697
01553-06721	Nissan	1949	11500996	G.M.	5955
01553-09241	Nissan	9294	11501102	G.M.	9147
01553-0932	Nissan	9540	11501188	G.M.	5688
01553-09321	Nissan	9540	11501193	G.M.	9064
01553-09611	Nissan	10536	11501794	G.M.	9161
01553-S3500	Nissan	9539	11501835	G.M.	1041
01651-00481	Nissan	1572	11501836	G.M.	1042
04388293	Ford	5676	11501849	G.M.	1276
0501094C1	Navistar	9373	11501850	G.M.	1017
06504090	Chrysler	5675	11501884	G.M.	9160
10003294	G.M.	11309	11501889	G.M.	11191
10009923	G.M.	3010	11501932	G.M.	1041
10017487	G.M.	11304	11502449	G.M.	5550
10036503	G.M.	9854	11502609	G.M.	11191
10053182	G.M.	1446	11502617	G.M.	5560
10062	G.M.	1041	11502702	G.M.	5797
10063599	G.M.	5602	11502722	G.M.	5797
10077401	G.M.	9130	11502785	G.M.	5559
10121502	G.M.	9130	11502941	G.M.	5684
10125439	G.M.	9278	11503317	G.M.	10815
10126901	G.M.	9368	11503396	G.M.	5925
10143422	G.M.	1742	11503403	G.M.	5550
10157900	G.M.	9370	11503483	G.M.	5925
1016937	G.M.	5596	11503619	G.M.	9147
10169777	G.M.	5605	11503695	G.M.	5916X
10185925	G.M.	9132	11503715	G.M.	10812
10242298	G.M.	9992	11503716	G.M.	5596
10293674	G.M.	5609	11503752	G.M.	5910
10297368	G.M.	9991	11503754	G.M.	5915
10297371	G.M.	9990	11503756	G.M.	5915
10323057	G.M.	10357	11503800	G.M.	5682
10352797	G.M.	10489	11503823	G.M.	5684
10352799	G.M.	9967	11503825	G.M.	11135
10411395	G.M.	10058	11503834	G.M.	5686
10423553	G.M.	9914	11503892	G.M.	5550
10431523	G.M.	10488	11503941	G.M.	5684
10431761	G.M.	10058	11503957	G.M.	5596
10437565	G.M.	9969	11503982	G.M.	5690
10443956	G.M.	9915	11504056	G.M.	9888
10998-30880	Nissan	1597	11504492	G.M.	5697
11500401	G.M.	5916X	11504531	G.M.	5750
11500434	G.M.	5550	11504614	G.M.	1639
11500658	G.M.	5559	11504766	G.M.	5984
11500660	G.M.	5560	11505022	G.M.	5950
11500661	G.M.	10815	11505023	G.M.	5955

O.E.M. Interchange

O.E.M. #	Make	Carolina #	O.E.M. #	Make	Carolina #
11505044	G.M.	5692	14070914	G.M.	5775
11505104	G.M.	5791	14071289	G.M.	5676
11505214	G.M.	5915	14074081	G.M.	5995
11505329	G.M.	5910	14093088	G.M.	5935
11506099	G.M.	10812	14093311	G.M.	5429
11506174	G.M.	5684	1480627	G.M.	2969
11507036	G.M.	11191	149251	Chrysler	938
11508241	G.M.	10812	1494252	G.M.	2969
11508900	G.M.	1041	1494253	G.M.	1835
11508925	G.M.	5560	1494254	G.M.	5412
11513801	G.M.	9888	1494257	G.M.	5480
11514970	G.M.	1695	1494258	G.M.	1836
11515619	G.M.	5697	15116576	G.M.	10482
11518017	G.M.	10504	15127746	G.M.	10480
11518357	G.M.	10129	15149708	G.M.	9617
11561368	G.M.	10375	15221959	G.M.	10429
11561491	G.M.	10651	152273	G.M.	938
11562563	GM	10827	15282120	G.M.	10482
11569768	G.M.	5625	15288146	G.M.	10481
11569918	GM	10823	15296830	G.M.	10370
11588950	G.M.	10568	153297	Chrysler	11027
11589289	G.M.	10368	15506827	G.M.	5770
11589290	G.M.	10369	15506921	G.M.	5770
11589291	G.M.	10367	15545202	G.M.	1646
11589292	G.M.	10371	15552345	G.M.	5995
11589293	G.M.	10374	15562609	G.M.	2115
11589294	G.M.	10372	15562610	G.M.	9233
11589295	G.M.	10377	15591860	G.M.	9164
11589296	G.M.	10378	15595172	G.M.	9054
11609417	G.M.	10239	15600382	G.M.	4020
1165051	G.M.	9879	1560058	Chrysler	9879
12337873	G.M.	5412	15607165	G.M.	9339
12337920	G.M.	9242	15612948	G.M.	9339
12338025	G.M.	11284	15633873	G.M.	1172
12338074	G.M.	2114	15638413	G.M.	2017
12338153	G.M.	9851	1564180	G.M.	1001
12493-05167B	Hyundai	10763	15653790	G.M.	9825
12920	Ford	11309	15672713	GM	10960
14004876	G.M.	11304	15685040	G.M.	9164
14013246	G.M.	2940	15686142	G.M.	9199
14017701	G.M.	11301	15691493	G.M.	2114
14017705	G.M.	11306	15691595	G.M.	9164
14019205	G.M.	5675	15691595X	G.M.	9164
14019206	G.M.	5675	15694099	G.M.	11041
14019226	G.M.	5676	15705372	G.M.	972
14031114	G.M.	11307	15872008	G.M.	10651
14045480	G.M.	5677	15893516	G.M.	10481
14047034	G.M.	11300	15955172	G.M.	9054
14063981	G.M.	5770	15958694	Chrysler	5625

O.E.M. Interchange

O.E.M. #	Make	Carolina #	O.E.M. #	Make	Carolina #
15959832	G.M.	10382	20699808	G.M.	JL-23
15960325	G.M.	2029	20709017	G.M.	5618
15963179	G.M.	2017	20729523	G.M.	JL-24
15964971	G.M.	2114	20730531	G.M.	9559
15964972	G.M.	2115	2094869	Chrysler	1095
15967691	G.M.	9164	21030249	G.M.	1860
15969147	G.M.	1860	21039129	G.M.	2167
15975244	G.M.	8862B	21042958	G.M.	1558
1605396	G.M.	5625	21075686	G.M.	1861
1614858	G.M.	11304	21077123	G.M.	9559
1617333	G.M.	11309	21077575	G.M.	2016
1619321	G.M.	5710	21094146	G.M.	JL-33
1621253	G.M.	11303	21097292	G.M.	2016
1624705	Chrysler	347	21110122	G.M.	9128
1631564	G.M.	5648	21110201	G.M.	JL-33
16632192	G.M.	2115	22508050	G.M.	11308
16632193	G.M.	2114	22508051	G.M.	11302
16656935X	G.M.	5264	22512276	G.M.	9352
1699250	G.M.	5995	22531616	G.M.	5558
175-553-577A	Volkswagen	5775	22538004	G.M.	9067
175720B010	Chrysler	5676	22547243	G.M.	10366
175-852-577	Volkswagen	5769	22603384	G.M.	10056
175-853-577	Volkswagen	5769	22718305	G.M.	5635
175-853-57701C	Volkswagen	5769	25016383	G.M.	8172
175-853-577A	Volkswagen	5775	25618730	G.M.	1609
20046147	G.M.	1288	25648693	G.M.	10128
20064875	G.M.	1930	25722671	G.M.	10059
20175051	G.M.	1172	25724529	G.M.	10680
20184399	G.M.	9851	272766	G.M.	11308
20319841	G.M.	9374	2964547	G.M.	JL-32
20351035	G.M.	5686	2998430	Chrysler	639
20374473	G.M.	9242	3065575	G.M.	5264
20413107	G.M.	8172	3078511	G.M.	5440
20421672	G.M.	9054	3239826	AMC	11303
20421800	G.M.	4020	332364	G.M.	5429
20423550	G.M.	6010	34201287	Chrysler	5682
20423647	G.M.	9053	34201621	Chrysler	5675
20429500	G.M.	1268	34202335	Chrysler	5640
20432975	G.M.	5769	34202672	Chrysler	9369
20433026	G.M.	5775	34202787	Chrysler	5648
20452072	G.M.	1390	34202855	AMC	5769
20510029	G.M.	9369	342271	G.M.	1095
20514862	G.M.	1583	343541	G.M.	972
20570245	G.M.	5940	343542	G.M.	972
20590899	G.M.	9369	343543	G.M.	972
20603072	G.M.	9548	343555	G.M.	972
2064891	G.M.	592	3441743	Chrysler	11301
20664091	G.M.	9968	347347	G.M.	2980
20664092	G.M.	9067	354076	G.M.	972

O.E.M. Interchange

O.E.M. #	Make	Carolina #	O.E.M. #	Make	Carolina #
357020	G.M.	11308	3895904	Ford	11306
358560	Ford	9879	390018-S	Ford	9130
362379	G.M.	972	3907444	G.M.	1228
3671410	Chrysler	11308	391039-S	Ford	5627
367292	G.M.	9371	3919773	G.M.	1574
3673945	AMC	11308	3921446	G.M.	972
3691590	Chrysler	5429	3963228	G.M.	11310
3691590	Chrysler	5625	3977775	G.M.	5440
3722635	G.M.	345	400141	AMC	9111
373846-S	Ford	11308	4003120	AMC	1095
3751212	Chrysler	11306	4004569	AMC	5429
3786805	Chrysler	1835	4004919	AMC	5625
379046-S	G.M.	1228	4005099	AMC	9373
379830-S	Ford	1842	4005470	AMC	1024
379831-S	Ford	1836	4006516	AMC	8172
380382	G.M.	9111	407217	G.M.	1001
380614-S	Ford	10640	4095145	Chrysler	11300
380615-S	Ford	10639	4104998	Chrysler	11302
381801-S2	Ford	6010	411700	G.M.	5506
381863-S2	Ford	5750	4167810	Chrysler	11309
383000	Ford	11300	4241296	Chrysler	11301
383001	Ford	11301	4341060	Chrysler	1865
383003	Ford	11302	4370132	Chrysler	5775
383005	Ford	11304	4370138	Chrysler	9128
383142-S	Ford	10424	445429	G.M.	11040
38439S47	Ford	5765	45263-S2	Ford	2969
385189-S100	Ford	4007	45265-S2	Ford	5412
385323-S100	Ford	4008	45267	Ford	5480
385353-S	Ford	10646	45269	Ford	5466
385595-S	Ford	9588	45269-S	Ford	5466
385661-S	Ford	1024	4658673	Chrysler	5609
386553-S	Ford	9588	4676189	G.M.	9711
387477-S	Ford	9372	4696129	Chrysler	2016
38766-S	Ford	10639	472812	G.M.	11303
388034	Ford	11309	472815	G.M.	11305
388047-S102	Ford	4009	4755299	G.M.	1228
388246A	Ford	8172	4759145	G.M.	308
388442-S100	Ford	4002	4761842	G.M.	308
388577S	Ford	5625	4779348	G.M.	308
388664-S100	Ford	4005	4857136	Chrysler	9369
388916-S	Ford	10648	4876498	G.M.	1991
388930-S	Ford	5627	4878883AA	Chrysler	9980
389129-S	Ford	10645	4879431	G.M.	552
389138	Ford	11302	51-11-8-174-185	BMW	11137
389268-S100	Ford	9851	5116530AA	Chrysler	10370
389358	Ford	5429	52161-02020	Toyota	9327
389358S	Ford	5625	52161-16010	Toyota	9327
3893980	G.M.	2980	528846	G.M.	1095
389443-S	Ford	9849	53879-14010-A	Toyota	1601

O.E.M. Interchange

O.E.M. #	Make	Carolina #	O.E.M. #	Make	Carolina #
53879-14020	Toyota	1601	6500898	Chrysler	1195
5480852	G.M.	10485	6500899	Chrysler	5769
55074801	Chrysler	5677	6500911	Chrysler	5770
556196	G.M.	1003	6501067	Chrysler	5632
557057	G.M.	1003	6501178	Chrysler	1621
560625	G.M.	11302	6501301	Chrysler	JL-33
568792	G.M.	9879	6501559	Chrysler	1390
56902-S2	Ford	5791	6501792	Chrysler	1621
56904-S2	Ford	5984	6501916	Chrysler	10366
56912-S2	Ford	2970	6501948	Chrysler	5610
56912-S61	Ford	2970	6502078	Chrysler	5625
56914-S2	Ford	2975	6502104	Chrysler	5628
574355	G.M.	9879	6502328	Chrysler	JL-23
57728AC090	Subaru	9294	6502709	Chrysler	2112
5973400	G.M.	5672	6502790	Chrysler	9067
5GUU9K111BA	Chrysler	10377	6502842	Chrysler	2167
6000705	Chrysler	345	6502871	Chrysler	9968
6003349	Chrysler	1024	6502907	Dodge	2063
6010029	Chrysler	9879	6503221	Chrysler	9352
6013029	Chrysler	345	6503454	AMC/Jeep	5675
6030441	Chrysler	5625	6503598	Chrysler	1860
6030539	G.M.	5765	6503860	Chrysler	9128
6031091	Chrysler	4008	6503896	Chrysler	2063
6031115	Chrysler	4007	6504014	Chrysler	2063
6031321	Chrysler	5429	650403	Chrysler	5643
6031438	Chrysler	9371	6504043	Chrysler	5643
6032723	Chrysler	5984	6504098	Chrysler	2111
6032926	Chrysler	9902	6504521	Chrysler	2133
6033082	G.M.	9130	6504555	Chrysler	1861
6033705	Chrysler	1095	6505292AA	Chrysler	2108
6033862	Chrysler	9373	6505878AA	Chrysler	2112
6035201	Chrysler	1951	6505918-AA	Chrysler	10464
6036007AA	Ford	5625	6506007AA	Chrysler	1390
6036148-AA	Chrysler	10966	6506788	Chrysler	5635
6100049	Chrysler	5915	6508712AA	Chrysler	10375
6100566	Chrysler	5698	6508863AA	Chrysler	10368
62217-13010	Toyota	10751	6542907	Dodge	2063
6271989	G.M.	1288	65832-F5000	Nissan	2025
63844-01A00	Nissan	5648	65846-30F00	Nissan	2025
63844-01A00	Nissan	5901	66814-01G00	Nissan	1756
63848-9E001	Nissan	10356	66860-01W01	Nissan	2028
63854-01A00	Nissan	10538	67771-01010	Toyota	9081
63876-95596	Nissan	5920	67771-12010	Toyota	9081
63876-D5596	Nissan	5920	67771-12080	Toyota	10748
6387801E10K0A	Nissan	11024	67771-30070	Toyota	2145
6466355	G.M.	11309	68425-H5000	Nissan	1296
6500725	Chrysler	1263	74798-S90000	Mazda	1572
6500859	Chrysler	5769	75392-60030	Lexus	10491

O.E.M. Interchange

O.E.M. #	Make	Carolina #	O.E.M. #	Make	Carolina #
75394-60060	Lexus	10397	90189-06157	Toyota	9913
75395-33030	Lexus	10493	90321122	G.M.	10703
75397-35010	Toyota	10492	90467-06017	Toyota	1603
75492-60030	Lexus	10396	90467-06017-20	Toyota	1603
75495-35010	Toyota	10490	90467-06161-01	Toyota	9074
75498-42010	Toyota	10394	90467-07043	Toyota	9114
75521-611-0000	Honda	1614	90467-07043-C0	Toyota	9114
75522-611-000	Honda	1577	90467-07050	Toyota	1466
75522-611-0000	Honda	1577	90467-07164	Toyota	10570
75867-21010	Toyota	10750	90467-07166	Toyota	9465
76882-57A00	Nissan	1975	90467-07201	Toyota	10569
76906-T3000	Nissan	1634	90467-08004	Toyota	1996
76916-T3000	Nissan	1634	90467-08011	Toyota	1996
77553-65D00	Suzuki	10392	90467-09008	Toyota	1950
796255	G.M.	9373	90467-09050	Toyota	10141
800843	Ford	11303	90467-09069-06-20	Toyota	1634
802781-S	Ford	5935	90467-09069-06-21	Toyota	1634
8048635	Ford	5769	90467-09127	Toyota	9646
807389S	Ford	1860	90467-10183	Toyota	10450
8083265000	Datsun	9560	90467-10188	Toyota	10687
80833-8500	Datsun	9560	90467-11005	Honda	1634
80999-05N07	Nissan	9114	90467-11063	Toyota	10392
80999-VE000	Nissan	10576	90467-11100	Toyota	10112
81126-37010	Hyundai	10782	90467-A0003	Toyota	10141
82315-38000	Hyundai	10744	90468-04030	Toyota	1584
86590-28000	Hyundai	9287	90505-SM-003	Honda	1973
874-298-1190	Isuzu	1597	90505-SM4-003	Honda	1973
88969790	G.M.	10750	90505-SX0-003	Honda	10075
88970767	G.M.	10450	90602-SAA-003	Honda	10752
8911472	G.M.	1239	90657-SA6-0030	Honda	2015
893202-599	AMC	1742	90661-SC7-0030	Honda	1572
8934201287	AMC	10984	90662-671-0030	Honda	1296
8934-201-621	AMC	5675	90662-693-003	Honda	9591
8934-201-631	AMC	5770	90662-693-0030	Honda	9591
8934-202-599	AMC	1742	90664-671-0030	Honda	9560
89421-76980	Isuzu	1634	90672-671-8110M1	Honda	1636
8942264920	Isuzu	9081	90672-SA0-0030	Honda	9279
8942981190	Isuzu	1597	90675-SB0-003	Honda	5920
90114-SE0-000	Honda	10096	90675-SB3-003	Honda	5920
90189-04013	Toyota	1636	90684-SA5-003	Honda	1597
90189-04042	Toyota	1577	90684-SA5-0030	Honda	1597
90189-04066	Toyota	9591	90687-SA5-0030	Honda	9554
90189-05013	Toyota	1560	90700-SJ4-000	Acura	9945
90189-06001	Toyota	1576	90904-67036	Toyota	10113
90189-06010	Toyota	1614	90904-67037	Toyota	9946
90189-06013	Toyota	1605	91500-SM4-999AH	Honda	2123
90189-06028	Toyota	9912	91501-S04-003	Honda	9292
90189-06042	Toyota	1572	91501-S1K-003	Honda	10435
90189-06065	Toyota	11389	91502-SM4-000	Honda	D-123

O.E.M. Interchange

O.E.M. #	Make	Carolina #	O.E.M. #	Make	Carolina #
91502-SM4-0000	Honda	D-123	9926-50-625	Mazda	1603
91502-SP0-003	Honda	2060	9927-40-822	Mazda	10405
91503-SP0-003	Honda	9202	9927-40-825	Mazda	9081
91503-SP0-0030	Acura	9202	9928-91-053353	Mazda	9279
91503-SZ3-003	Honda	9282	9991-00-412	Mazda	1577
91503-SZ5-003	Honda	9382	9991-00-503	Mazda	1296
91504-SM4-000	Honda	D-124	9991-00-601	Mazda	1614
91504-SM4-0000	Honda	D-124	B092-51-833	Mazda	9287
91512-SM4-003	Honda	1976	B455-56-741	Mazda	9053
91512-SX0-003	Acura	2128	C5ZZ-6543413-B	Ford	9550
91518-SM4-003	Honda	9262	D1AB-6542413-AB	Ford	9550
91520-SM4-C01	Honda	5606	D1AZ-6522841A	Ford	1267
91520-SM4-C010	Honda	5606	D1AZ-6542113-B	Ford	9550
91530-SP1-003	Honda	9208	D9AE-9E645AA	Ford	11305
91530-SPL-003	Honda	9208	E308-4A163CA	Ford	5675
91560-S9A-A01	Honda	10573	E7EB5802354AAJABH	Ford	JL-120
91560-SM4-003	Honda	9444	E9DB-13N020AA	Ford	1864
91619-SA5-003	Honda	1614	E9DZ-13N129A	Ford	1864
93904-46320	Toyota	2123	F2AB-13N020-AA	Ford	1864
94051993	G.M.	2028	F3LB-14K056-AA	Ford	1861
94198687	G.M.	2015	FB01-56-964	Mazda	5920
9422552	G.M.	11040	G18K-51-SJ3	Mazda	10749
9423101	G.M.	10455	GA2A-68-AB1A	Mazda	10575
9424837	G.M.	1350	H001-50-841	Mazda	1572
9428738	Chrysler	5984	KA01500Z1	Ford	5770
9431532	G.M.	1192	MB-098145	Mitsubishi	1576
9433043	G.M.	5559	MB-455-56143	Ford	9287
9433155	G.M.	5750	MB547806	Mitsubishi	10538
9436175	G.M.	4007	MNA01-56145	Ford	5901
9437486	G.M.	9902	MR200300	Mitsubishi	9943
9437938	G.M.	4008	MR3289541	Chrysler	9540
9440178	G.M.	5750	MS480001	Mitsubishi	9111
9441592	GM	10960	MS-480001	Mitsubishi	1577
94530565	G.M.	10744	MS480002	Mitsubishi	1560
94841764	G.M.	1560	MS-480012	Mitsubishi	1572
95900-04036	Toyota	1577	MU000319	Mitsubishi	2128
9606232	G.M.	9548	N304-13-356-A	Mazda	2015
9616231	G.M.	5765	N606676-S	Ford	5698
9662950	G.M.	9548	N606676-S100	Ford	5698
96706-B0700	Nissan	1577	N606676-S2	Ford	5698
96706-P0105	Nissan	1614	N606677-S	Ford	5705
96706-U0100	Toyota	1576	N621903-S2	Ford	1639
96706-W100	Toyota	1605	N621940	Ford	5916X
9685057	G.M.	1024	N623332	Ford	5596
9721917	G.M.	1267	N623332-S100	Ford	5596
97606-B0700	Datsun	1577	N623332-S2	Ford	5596
9818648	G.M.	592	N623332-S53	Ford	5596
9883583	G.M.	592	N623333-S100	Ford	5560
9926-40-658	Mazda	1634	N623333-S2	Ford	5560

O.E.M. Interchange

O.E.M. #	Make	Carolina #	O.E.M. #	Make	Carolina #
N623343-S100	Ford	10815	W709002-SAA	G.M.	10568
N623343-S2E45	Ford	10815	W709346-S300	Ford	9130
N800369-S2	Ford	1939	W712196S300	Ford	10374
N80101994S	Ford	JL-26	W713331-S300	Ford	10367
N801192S36	Ford	1621			
N801603-S61	Ford	10365			
N801925	Ford	1575			
N801925-S	Ford	1575			
N802734S	Ford	5635			
N802781-S	Ford	5935			
N802900	Ford	1558			
N803043-S	Ford	5770			
N803170-S	Ford	9178			
N803362-S	Ford	9369			
N803421-S	Ford	1263			
N803862-S	Ford	1390			
N803934-S	Ford	5940			
N803946S	Ford	9968			
N804193-S100	Ford	10960			
N804349S	Ford	2048			
N804379S	Ford	5648			
N804570S	Ford	9067			
N804614S	Ford	5940			
N804675S	Ford	9128			
N805155-S	Ford	2112			
N805592-S100	Ford	1609			
N805612-S	Ford	1742			
N805612-S100	Ford	1742			
N805759-S100	Ford	9118			
N806830-S100	Ford	1951			
N806860-S100	Ford	1951			
N807389S	Ford	1860			
N807438S	Ford	9208			
N807721-S	Ford	5643			
N808370-S	Ford	5614			
N808842-S	Ford	2111			
N900-845-01	Volkswagen	9277			
N90100001	Volkswagen	5910			
N98905101	Volkswagen	1024			
NA01-56145	Ford	5901			
W701054-5300	Ford	5940			
W704340-S300	Ford	5935			
W704643	Honda	9208			
W705436-F300	Ford	9559			
W705589-S300	Ford	5625			
W706812S300	Ford	2108			
W707889-S300	Ford	10064			
W708530-S300	Ford	10504			
W709002	Ford	10568			